

CAM FOLLOWERS

- Standard Type Cam Followers
- Stainless Steel Made Cam Followers
- Eccentric Type Cam Followers
- Solid Eccentric Stud Type Cam Followers
- Thrust Disk Type Cam Followers
- Centralized Lubrication Type Cam Followers
- Easy Mounting Type Cam Followers
- Cam Follower G
- C-Lube Cam Followers
- Miniature Type Cam Followers
- Stainless Steel Made Miniature Cam Followers
- Thrust Disk Type Miniature Cam Followers
- Cylindrical Roller Cam Followers
- Inch series Cam Followers



Structure and Features

IKO Cam Followers are bearings with a stud incorporating needle rollers in a thick walled outer ring. These bearings are designed for outer ring rotation, and have superior rotational performance with a small coefficient of friction and high load capacity.

As studs already have threads or steps, they are easy to mount.

Cam Followers are follower bearings for cam mechanisms and linear motions and have high rigidity and

high accuracy. They are, therefore, used widely for machine tools, industrial robots, electronic devices, and OA equipment.

Stainless steel made Cam Followers are superior in corrosion resistance and suitable for applications in environments where oil cannot be used or water splashed, and in clean rooms.

Structure of Cam Followers

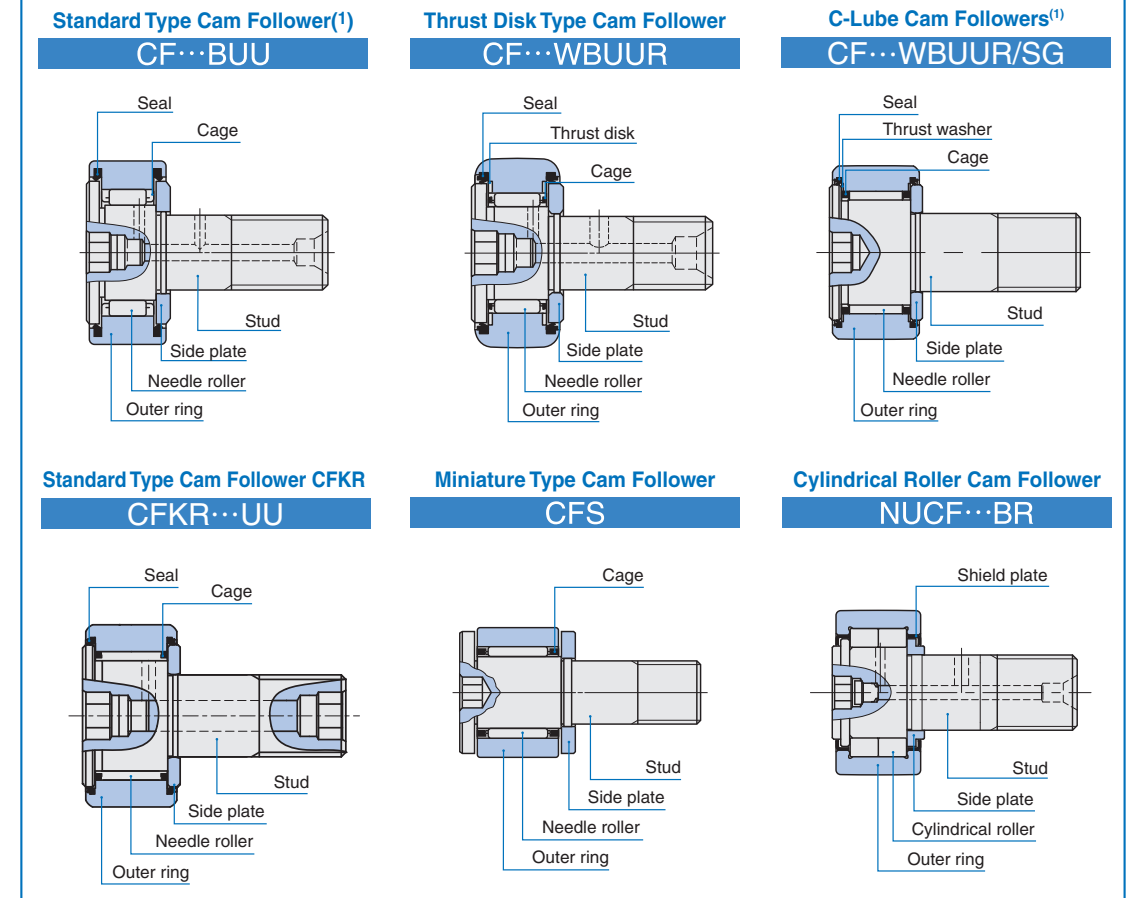

Note(1) Thermosetting solid-type lubricant C-Lube fills inner space of the bearing.

I
CF
CFKR
CFS
NUCF
CR

For Cam Followers, the types shown in Table 1 are available.

Table 1 Type of Cam Followers

Bearing Model		Item	With cage		Full complement		
			Crowned outer ring	Cylindrical outer ring	Crowned outer ring	Cylindrical outer ring	
Standard Type Cam Follower CF...B CFKR	High carbon steel made	Stud Head Hex Hole	Shield type	CF ... B R	CF ... B	CF ...V B R	CF ... V B
			Sealed type	CF ... B UUR	CF ... B UU	CF ...V B UUR	CF ... V B UU
	Stainless steel made	Stud Head Hex Hole	Shield type	CF ...F B R	CF ...F B	—	—
			Sealed type	CF ...F B UUR	CF ...F B UU	—	—
	High carbon steel made	Double Hex Hole	Shield type	CFKR... R	CFKR	CFKR...V R	CFKR... V
			Sealed type	CFKR... UUR	CFKR ... UU	CFKR...V UUR	CFKR... V UU
Eccentric Type Cam Followers CFE...B CFKRE	High carbon steel made	Stud Head Hex Hole	Shield type	CFE ... B R	CFE ... B	CFE ...V B R	CFE ... V B
			Sealed type	CFE ... B UUR	CFE ... B UU	CFE ...V B UUR	CFE ... V B UU
	High carbon steel made	Double Hex Hole	Shield type	CFKRE ... R	CFKRE	CFKRE...V R	CFKRE... V
			Sealed type	CFKRE ... UUR	CFKRE ... UU	CFKRE...V UUR	CFKRE... V UU
Solid Eccentric Stud Type Cam Followers CFES...B	High carbon steel made	With hexagon hole	Shield type	CFES... B R	CFES... B	—	—
			Sealed type	CFES... B UUR	CFES... B UU	—	—
Thrust Disk Type Cam Followers CF...WB	High carbon steel made	With hexagon hole	Shield type	CF ... WB R	—	—	—
			Sealed type	CF ... WB UUR	—	—	—
	Stainless steel made		Shield type	CF ...F WB R	—	—	—
			Sealed type	CF ...F WB UUR	—	—	—
Centralized Lubrication Type Cam Followers CF-RU1, CF-FU1	High carbon steel made	With screwdriver slot	Sealed type	CF-RU1	CF-FU1	—	—
Easy Mounting Type Cam Followers CF-SFU...B	High carbon steel made	With hexagon hole	Sealed type	—	CF-SFU... B	—	—
Cam Follower G CF...G	High carbon steel made	With hexagon hole	Shield type	—	CF ...G	—	—
C-Lube Cam Followers CF...WB.../SG	High carbon steel made	With hexagon hole	Sealed type	CF ...WB.../SG	—	—	—
Miniature Type Cam Followers CFS	High carbon steel made	With hexagon hole	Shield type	—	CFS	—	CFS ... V
	Stainless steel made		Shield type	—	CFS ...F	—	CFS ...F V
Thrust Disk Type Miniature Cam Followers CFS...W	High carbon steel made	With hexagon hole	Shield type	—	CFS ... W	—	CFS ...WV
	Stainless steel made		Shield type	—	CFS ...F W	—	—
Cylindrical Roller Cam Followers NUCF...B	High carbon steel made	With hexagon hole	Shield type	—	—	NUCF... B R	—
Inch series Cam Followers CR	High carbon steel made	With hexagon hole	Shield type	CR ... B R	CR ...B	CR ...V B R	CR ... V B
			Sealed type	CR ... B UUR	CR ...B UU	CR ...V B UUR	CR ... V B UU
		With screwdriver slot	Sealed type with ThrustDisk Seals™	—	—	CR ...V B S R	CR ... V B S
			Shield type	CR ... R	CR	CR ...V R	CR ... V
High carbon steel made	With screwdriver slot	Sealed type	CR ... UUR	CR ... UU	CR ...V UUR	CR ... V UU	
		Shield type	—	—	CRH...V B R	CRH... V B	
Inch series Cam Followers CRH...B	High carbon steel made	With hexagon hole	Sealed type	—	—	CRH...V B UUR	CRH... V B UU

Standard Type Cam Followers

These are the basic type bearings in IKO Cam Follower series. Standard Type Cam Followers CF...B with stud diameters ranging from 3 mm to 30 mm are available, and are suitable for a wide range of applications. Standard Type Cam Followers CFKR have sockets with hexagon holes on both stud ends, which allow mounting with a hexagon wrench from either side.

Eccentric Type Cam Followers

The eccentric stud can be rotated to create a uniform line, enabling easy adjustment for even load distribution across the outer ring outer surface. Eccentricity is 0.4 (CFE) ~ 1.5 mm.

Solid Eccentric Stud Type Cam Followers

The eccentric stud can be rotated to create a uniform line, enabling easy adjustment for even load distribution across the outer ring outer surface. These are eccentric cam followers with an integrated stud that can be mounted in the same mounting holes as those for Standard Type Cam Followers. Eccentricity is from 0.25 mm to 0.6 mm.

Thrust Disk Type Cam Followers

The thrust disk seal, made of special synthetic resin with excellent abrasion and heat resistance, is incorporated in the sliding contact area between the shoulders of the outer ring and the stud head and side plate. This prevents friction and abrasion inside the bearing due to axial loads caused by mounting errors.

Centralized Lubrication Type Cam Followers

These bearings have one or two pipe-threaded holes in the stud. Thus, this series is suitable when centralized lubrication is required.

Easy Mounting Type Cam Followers

These bearings have a stepped tapered portion on the stud. When mounting the Cam Follower, it is easy to fix its location by tightening a set screw to the stepped portion. Thus, this type is suitable when a large number of Cam Followers are used in a machine such as a pallet changer.

C-Lube Cam Followers

These bearings are lubricated with a newly developed thermosetting solid-type lubricant which fills the inner space of the bearing. This lubricant provides long-term maintenance free.

Miniature Type Cam Followers

These are compactly designed bearings, incorporating very thin needle rollers in an outer ring with a small outside diameter. They are used in electronic devices, OA equipment, small index devices, etc.

Cylindrical Roller Cam Followers

These bearings are full complement type bearings incorporating double rows of full complement cylindrical rollers in the outer ring, and can withstand large radial loads. Additionally, the outer ring is guided by the outer ring shoulder and the end face of cylindrical rollers to the axial direction.

Inch series Cam Followers

Two types, CR and CRH, are available in the Inch series Cam Followers. Black oxide film treatment is made on CRH models. CR with ThrustDisk Seals™ prevents the ingress of foreign substances as well as friction and abrasion on the interior of the bearing caused by axial load generated due to mounting errors.

Lubrication method of Hex Head Cam Followers

(Types) Standard Type, Eccentric Type, Solid Eccentric Stud Type, Thrust Disk Type, Easy Mounting Type, Cylindrical Roller Type.

1 Way

Stud dia. 5~10mm⁽¹⁾

Re-greasing fitting is incorporated in the stud head.

3 Ways

Stud dia. 12~30mm

Grease nipple is incorporated in the stud head.

Remark : All Easy Mounting Type have a 1way port.
 Note (1) CFKR and CFKRE can be lubricated from both head part and thread side.
 Also, a grease nipple is built into the stud head.

I
CF
CFKR
CFS
NUCF
CR

Internal Structures and Shapes

The Cam Follower series has various types, such as high carbon steel type, stainless steel type, caged type, full complement type, shield type, sealed type,

type with crowned outer ring, type with cylindrical outer ring, etc.

Type of material

In addition to high carbon steel products, stainless steel products are also available. Stainless steel products are suited for applications where oil cannot be used or where water splashes, and in cleanrooms.

《High carbon steel made》 《Stainless steel made》

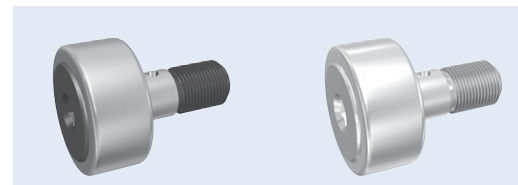

Roller guide method

Cam Followers include the caged type and the full complement type. The caged type has a small coefficient of friction and is suitable for high speed rotations, while the full complement type is suitable for heavy loads at low speed rotations.

《With cage》 《Full complement》

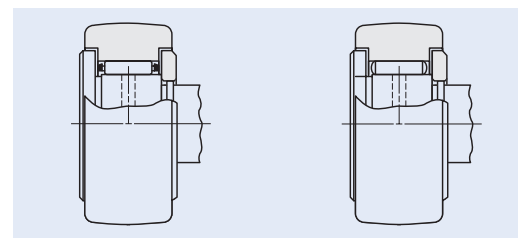

Seal structure

Available Cam Followers include the shield type, the sealed type, and type with ThrustDisk Seals™. In the shield type, labyrinths are formed by the narrow clearances between the outer ring and the stud flange, and between the outer ring and the side plate. The sealed type incorporates seals in the narrow clearances (the shield type labyrinths) to prevent the ingress of foreign substances. The sealed type with ThrustDisk Seals™ prevents grease leakage and the ingress of foreign substances into the bearing interior. It also prevents friction and abrasion on the interior of the bearing caused by axial load generated due to mounting errors.

《Shield type》 《Sealed type》

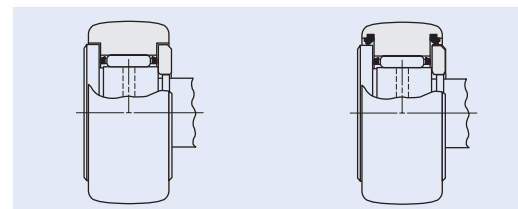

《Sealed type with ThrustDisk Seals™》 (1)

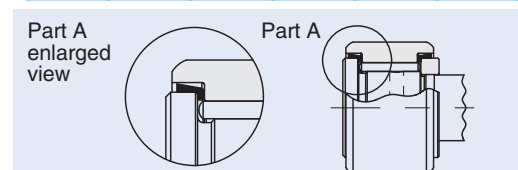

Notes(1) Applicable only to Inch Series Cam Followers CR (Stud Head Hex Hole)

Shape of outer ring outside surface

The outside surface of the outer ring of Cam Followers, which makes direct contact with the mating cam guide surface, is either crowned or cylindrical. The crowned outer rings are effective in moderating the edge load due to mounting errors. The cylindrical outer rings have a large contact area with the mating cam guide surface, and are suitable for applications in which the applied load is large or the cam guide surface hardness is low.

《Crowned outer ring》 《Cylindrical outer ring》

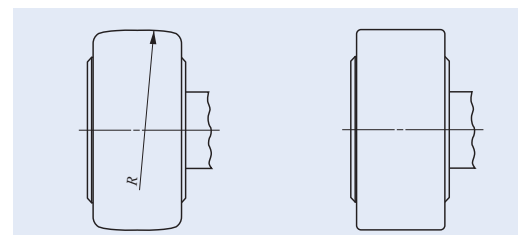

Identification number

Some examples of the identification number of Cam Followers are shown below. For applicable material symbol, roller guide method, seal structure and shape of outer ring outside surface, refer dimension table of each series.

Examples of identification number

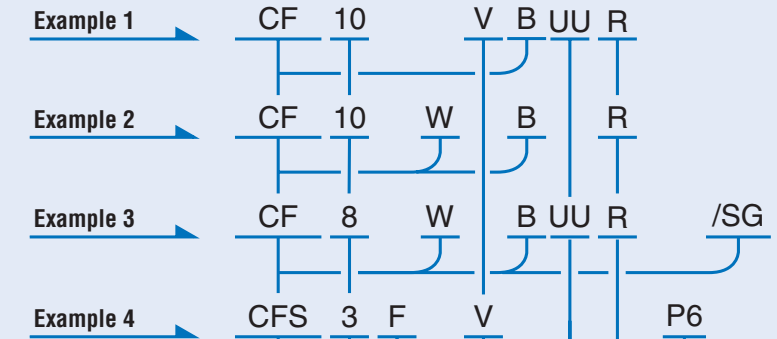

Model code	
CF...B	Standard Type Cam Follower(Stud Head Hex Hole)
CFKR	Standard Type Cam Follower(Double Hex Hole)
CFE...B	Eccentric Type Cam Followers(Stud Head Hex Hole)
CFKRE	Eccentric Type Cam Followers(Double Hex Hole)
CFES...B	Solid Eccentric Stud Type Cam Followers
CF...WB	Thrust Disk Type Cam Followers
CF-RU1	Centralized Lubrication Type Cam Followers(Crowned outer ring)
CF-FU1	Centralized Lubrication Type Cam Followers(Cylindrical outer ring)
CF-SFU...B	Easy Mounting Type Cam Followers
CF...G	Cam Follower G
CF...WB.../SG	C-Lube Cam Followers
CFS	Miniature Type Cam Followers
CFS...W	Thrust Disk Type Miniature Cam Followers
NUCF...B	Cylindrical Roller Cam Followers
CR	Inch series Cam Followers(With screwdriver slot)
CR...B	Inch series Cam Followers(Stud Head Hex Hole)
CRH...B	Inch series Cam Followers(Stud Head Hex Hole)

Size	
The value indicates a stud diameter. (unit: mm)	
For Double Hex Hole Cam Followers, the outside diameter of the outer ring is indicated.	
In the inch series, the outside diameter of the outerring in units of 1/16 inch is indicated.	

Material	
No symbol	High carbon steel made
F	Stainless steel made

Roller guide method	
No symbol	With cage type
V	Full complement type

Seal structure	
No symbol	Shield type
UU	Sealed type
S(1)	Sealed type with ThrustDisk Seals™

Notes(1) Applicable only to Inch Series Cam Followers CR (Stud Head Hex Hole)

Shape of outer ring outside surface	
R	With crowned outer ring
No symbol	With cylindrical outer ring

Classification symbol		
No symbol	Class 0	
P6	Class 6	Applicable to Miniature CFS series
P5	Class 5	
P4	Class 4	

I
CF
CFKR
CFS
NUCF
CR

Accuracy

The accuracy of Cam Followers is shown in Table 2, Table 3.1, Table 3.2 and Table 3.3. Cam Followers with special accuracy are also available. When they are required, please contact IKO.

Table 2 Tolerances

unit: μm

Series	Metric CF (1)		Miniature series CF	Inch series CF	
	Crowned outer ring	Cylindrical outer ring		Crowned outer ring	Cylindrical outer ring
Dimensions and symbols					
Outside dia. of outer ring D	0 -50	See Table 3.1	See Table 3.2	0 -50	See Table 3.3
Stud dia. d_1	h7		h6	+25 0	
Width of outer ring C	0 -120		0 -120	0 -130	

Note(1) Applicable to Cam Followers other than Miniature Type Cam Followers and Inch Series Cam Followers.

Table 3.1 Tolerances and allowable values of outer rings (Metric CF cylindrical outer rings(1))

unit: μm

D Nominal outside dia. of outer ring mm		Δ_{Dmp} Single plane mean outside dia. deviation		V_{Dsp} Outside dia. variation in a single radial plane (Max.)	V_{Dmp} Mean outside dia. variation (Max.)	K_{ea} Radial runout of assembled bearing outer ring (Max.)
Over	Incl.	High	Low			
6	18	0	- 8	10	6	15
18	30	0	- 9	12	7	15
30	50	0	-11	14	8	20
50	80	0	-13	16	10	25
80	120	0	-15	19	11	35

Note(1) Applicable to Cam Followers other than Miniature Type Cam Followers and Inch Series Cam Followers.

Table 3.2 Tolerances and allowable values of outer rings (Miniature series CF)

unit: μm

Δ_{Dmp} Single plane mean outside dia. deviation								K_{ea} Radial runout of assembled bearing outer ring (Max.)			
Class 0		Class 6		Class 5		Class 4		Class 0	Class 6	Class 5	Class 4
High	Low	High	Low	High	Low	High	Low				
0	-8	0	-7	0	-5	0	-4	15	8	5	4

Table 3.3 Tolerances and allowable values of outer rings (Inch series CF cylindrical outer ring)

unit: μm

D Nominal outside dia. of outer ring mm		Δ_{Dmp} Single plane mean outside dia. deviation		V_{Dsp} Outside dia. variation in a single radial plane (Max.)	V_{Dmp} Mean outside dia. variation (Max.)	K_{ea} Radial runout of assembled bearing outer ring (Max.)
Over	Incl.	High	Low			
6	18	0	-25	10	6	15
18	30			12	7	15
30	50			14	8	20
50	80			16	10	25
80	120			19	11	35

Clearance

The radial internal clearances of Cam Followers are shown in Table 4.

Table 4 Radial internal clearance

unit: μm

Metric CF series (2)	Miniature CFS series CF (3)	Cylindrical Roller Cam Followers NUCF...B	Inch series CF	Radial internal clearance	
				Min.	Max.
CF 3~CF 5	CFS1.4 ~CFS5	—	CR 8, CR 8-1, CRH 8-1, CRH 9	3	17
CF 6	CFS6	—	CR10, CR10-1, CRH10-1, CRH11	5	20
CF 8~CF12-1 CFKR22~CFKR32	—	—	CR12~CR22, CRH12~CRH22	5	25
CF16~CF20-1 CFKR35~CFKR52	—	—	CR24~CR36, CRH24~CRH36	10	30
CF24~CF30-2 CFKR62~CFKR90	—	—	CR48, CRH40~CRH56	10	40
—	—	—	CRH64	15	50
—	—	NUCF10 R~NUCF24 R	—	20	45
—	—	NUCF24-1R~NUCF30-2R	—	25	50

Note(1) Also applicable to full complement type, type with crowned outer ring, sealed type, and type with hexagon hole.

(2) Applicable to all Cam Followers other than Miniature Type Cam Followers, Cylindrical Roller Cam Followers and Inch Series Cam Followers.

(3) Applicable to all Miniature Type Cam Followers.

Fit

Tables 5 and 6 show recommended tolerances of mounting holes for Cam Follower studs. Since the Cam Follower is supported in a cantilever position, the mounting hole diameter should be prepared without play between the stud and the hole especially when heavy shock loads are applied.

Table 5 Recommended fit

Type	Tolerance class of mounting hole for stud
Metric CF	H7
Miniature series CF	H6
Cylindrical Roller Cam Followers	H7
Inch series CF	F7

Table 6 Dimensional tolerances of mounting hole

unit: μm

Nominal outside dia. of stud mm		F7		H6		H7	
Over	Incl.	Over	Incl.	Over	Incl.	Over	Incl.
—	3	+16	+ 6	+ 6	0	+10	0
3	6	+22	+10	+ 8	0	+12	0
6	10	+28	+13	+ 9	0	+15	0
10	18	+34	+16	+11	0	+18	0
18	30	+41	+20	+13	0	+21	0
30	50	+50	+25	+16	0	+25	0

Maximum Allowable Static Load

The applicable load on Cam Followers is, in some cases, limited by the bending strength and shear strength of the stud and the strength of the outer ring instead of the load rating of the needle roller bearing. Therefore, the maximum allowable static load that is limited by these strengths is specified.

Track Capacity

Track capacity is defined as the load which can be continuously applied on a Cam Follower placed on a steel cam guide surface without causing deformation or indentation on the cam guide surface when the outer ring of the Cam Follower makes contact with the mating cam guide surface (plane). The track capacities shown in Tables 7.1 and 7.2 are applicable when the hardness of the mating cam guide surface is 40HRC (Tensile strength 1250N/mm²). When the hardness of the mating cam guide surface differs from 40HRC, the track capacity is obtained by multiplying the value by the track capacity factor shown in Table 8.

If lubrication between the outer ring and the mating cam guide surface is insufficient, seizure and/or wear may occur depending on the application. Therefore, attention must be paid to lubrication and surface roughness of the mating cam guide especially for high-speed rotations such as cam mechanisms.

For lubrication between the outer ring and the mating cam guide surface, C-Lube Unit for Cam Followers is recommended. (See page I20.)

Table 7.1 Track load capacity

unit: N

Type of bearing	Identification number with crowned outer ring	Track capacity	Identification number with cylindrical outer ring	Track capacity
Metric CF ⁽¹⁾	CF 3 R	542	CF 3	1 360
	CF 4 R	712	CF 4	1 790
	CF 5 R	794	CF 5	2 210
	CF 6 R	1 040	CF 6	3 400
	CF 8 R	1 330	CF 8	4 040
	CF10 R · CFKR22R	1 610	CF10 · CFKR22	4 680
	CF10-1R · CFKR26R	2 030	CF10-1 · CFKR26	5 530
	CF12 R · CFKR30R	2 470	CF12 · CFKR30	7 010
	CF12-1R · CFKR32R	2 710	CF12-1 · CFKR32	7 480
	CF16 R · CFKR35R	3 060	CF16 · CFKR35	11 200
	CF18 R · CFKR40R	3 660	CF18 · CFKR40	14 500
	CF20 R · CFKR52R	5 190	CF20 · CFKR52	23 200
	CF20-1R · CFKR47R	4 530	CF20-1 · CFKR47	21 000
	CF24 R · CFKR62R	6 580	CF24 · CFKR62	34 300
	CF24-1R · CFKR72R	8 020	CF24-1 · CFKR72	39 800
	CF30 R · CFKR80R	9 220	CF30 · CFKR80	52 700
	CF30-1R · CFKR85R	9 990	CF30-1 · CFKR85	56 000
	CF30-2R · CFKR90R	10 800	CF30-2 · CFKR90	59 300
Miniature series CF ⁽²⁾	—	—	CFS1.4	128
	—	—	CFS2	220
	—	—	CFS2.5	298
	—	—	CFS3	485
	—	—	CFS4	799
	—	—	CFS5	1 210
—	—	CFS6	1 680	

Notes⁽¹⁾ Applicable to Cam Followers other than Miniature Type Cam Followers and Inch Series Cam Followers.

⁽²⁾ This table is applicable to all Miniature Type Cam Followers.

Table 7.2 Track capacity

unit: N

Type of bearing	Identification number with crowned outer ring	Track capacity	Identification number with cylindrical outer ring	Track capacity	Identification number with crowned outer ring	Track capacity	Identification number with cylindrical outer ring	Track capacity
Inch series CF ⁽¹⁾	CR 8 R	770	CR 8	2 140	—	—	—	—
	CR 8-1R	770	CR 8-1	2 360	CRH 8-1R	401	CRH 8-1	2 360
	—	—	—	—	CRH 9 R	469	CRH 9	2 650
	CR10 R	1 030	CR10	3 210	—	—	—	—
	CR10-1R	1 030	CR10-1	3 480	CRH10-1R	579	CRH10-1	3 480
	—	—	—	—	CRH11 R	658	CRH11	3 830
	CR12 R	1 340	CR12	4 500	CRH12 R	853	CRH12	4 500
	CR14 R	1 630	CR14	5 250	CRH14 R	1 050	CRH14	5 250
	CR16 R	1 970	CR16	7 280	CRH16 R	1 420	CRH16	7 280
	CR18 R	2 300	CR18	7 710	CRH18 R	1 660	CRH18	7 710
	CR20 R	2 680	CR20	10 700	CRH20 R	2 160	CRH20	10 700
	CR22 R	3 050	CR22	11 800	CRH22 R	2 450	CRH22	11 800
	CR24 R	3 410	CR24	15 400	CRH24 R	3 410	CRH24	15 400
	CR26 R	3 820	CR26	16 700	CRH26 R	3 820	CRH26	16 700
	CR28 R	4 210	CR28	21 000	CRH28 R	4 210	CRH28	21 000
	CR30 R	4 610	CR30	22 500	CRH30 R	4 610	CRH30	22 500
	CR32 R	5 050	CR32	30 900	CRH32 R	5 690	CRH32	30 900
	CR36 R	5 900	CR36	34 700	CRH36 R	6 640	CRH36	34 700
	—	—	—	—	CRH40 R	8 970	CRH40	45 000
	—	—	—	—	CRH44 R	10 200	CRH44	49 500
—	—	CR48	64 300	CRH48 R	11 400	CRH48	64 300	
—	—	—	—	CRH52 R	12 700	CRH52	69 600	
—	—	—	—	CRH56 R	14 100	CRH56	87 000	
—	—	—	—	CRH64 R	16 800	CRH64	113 000	

Notes⁽¹⁾ This table is applicable to all Inch series CF.

Table 8 Track capacity factor

Hardness HRC	Tensile strength N/mm ²	Track capacity factor	
		With crowned outer ring	With cylindrical outer ring
20	760	0.22	0.37
25	840	0.31	0.46
30	950	0.45	0.58
35	1 080	0.65	0.75
38	1 180	0.85	0.89
40	1 250	1.00	1.00
42	1 340	1.23	1.15
44	1 435	1.52	1.32
46	1 530	1.85	1.51
48	1 635	2.27	1.73
50	1 760	2.80	1.99
52	1 880	3.46	2.29
54	2 015	4.21	2.61
56	2 150	5.13	2.97
58	2 290	6.26	3.39



Allowable Rotational Speed

The allowable rotational speed of Cam Followers is affected by mounting and operating conditions. For d_1n values with only pure radial load applied, use the maximum values in Table 9 or lower as a guideline. Under actual operating conditions, use the recommended d_1n values in Table 9 as a guideline in consideration of the effect of axial loads.

For C-Lube Cam Followers, use a d_1n value of 10,000 or less as a guideline.

Table 9 d_1n values of Cam Followers⁽¹⁾

Type	Lubricant		Grease		Oil	
	Maximum	Recommended	Maximum	Recommended	Maximum	Recommended
Caged type	84 000	8 400	140 000	14 000		
Full complement type	42 000	4 200	70 000	7 000		
Cylindrical Roller Cam Follower	66 000	6 600	110 000	11 000		
C-Lube Cam Followers	10 000		10 000			

Note⁽¹⁾ d_1n value = $d_1 \times n$
 where, d_1 ⁽²⁾: Stud diameter mm
 n : Rotational speed min⁻¹

⁽²⁾ For Eccentric Type Cam Followers, thread diameter G as shown in the dimension table is applicable.

Lubrication

Grease-prepacked Cam Followers are shown in Table 10. The lubricating grease prepacked in these bearings is ALVANIA GREASE S2 (Shell Lubricants Japan K.K.).

For Cam Followers without prepacked grease, grease should be packed through the oil hole in the stud for use. If they are used without grease, wear of rolling contact surfaces may take place, leading to a short bearing life.

Table 10 Bearings with prepacked grease

○ : Prepacked × : Not prepacked

Series Size of stud diameter d_1 ⁽¹⁾ mm	Item	With cage				Full complement
		Shield type		Sealed type		
		With hexagon hole	With screwdriver slot	With hexagon hole	With screwdriver slot	
Standard Type Cam Follower	CF...B	3~ 5	○	-	○	-
	CFKR					
Eccentric Type Cam Followers	CFE...B	6~ 10	-	○	-	○
	CFKRE					
Solid Eccentric Stud Type Cam Followers	CFES...B	12~ 30	×	-	-	○
Thrust Disk Type Cam Followers	CF...WB					
Centralized Lubrication Type Cam Followers	CF-RU1, CF-FU1	-	-	-	○	-
Easy Mounting Type Cam Followers	CF-SFU...B	-	-	○	-	-
Cam Follower G	CF...G	○	-	-	-	-
C-Lube Cam Followers	CF...WB.../SG ⁽²⁾	-	-	×	-	-
Miniature Type Cam Followers	CFS	○	-	-	-	○
	CFS...W					
Cylindrical Roller Cam Followers	NUCF...B	-	-	-	-	○
Inch series Cam Followers	CR...B	With hexagon hole	$d_1 \leq 6.35$	-	-	-
		With screwdriver slot	$6.35 < d_1$	-	○	○
	CRH...B	With hexagon hole	$d_1 \leq 6.35$	○	-	-
		With screwdriver slot	$6.35 < d_1$	○	○	○

Notes⁽¹⁾ For Eccentric Type Cam Followers, thread diameter G as shown in the dimension table is applicable.

⁽²⁾ C-Lube, a thermosetting solid-type lubricant, fills the inner space of the bearing.

Oil Hole

The position of oil hole is shown in Table 11.

Perform greasing quietly by fitting a lubrication nozzle indicated in Table 12 to a straight type grease gun in JIS B 9808 and pressing the nozzle against the grease nipple or re-greasing fitting.

Due to their structures, lubrication is not possible for sizes 3 and 4 Standard Type Cam Followers CF...B, C-Lube Cam Followers, Cam Followers G and Miniature CFS series.

Table 11 Position of oil hole

○ : Oil hole is prepared.

Series Size of stud diameter d_1 ⁽¹⁾ mm	Oil hole position					
	① Head	② Stud outside surface	③ Stud end			
Standard Type Cam Follower	CF...B	$d_1 < 5$	-	-	-	
Eccentric Type Cam Followers	CFE...B	$5 \leq d_1 \leq 10$	○ ⁽³⁾	-	-	
Solid Eccentric Stud Type Cam Followers	CFES...B					
Thrust Disk Type Cam Followers	CF...WB	$10 < d_1$	○ ⁽²⁾	○	○	
Standard Type Cam Follower	CFKR	$d_1 \leq 10$	○ ⁽²⁾	-	○	
Eccentric Type Cam Followers	CFKRE	$10 < d_1$	○ ⁽²⁾	○	○	
Centralized Lubrication Type Cam Followers	CF-RU1, CF-FU1 ⁽⁴⁾	$d_1 \leq 12$	○	-	-	
		$12 < d_1$	○	○	○	
Easy Mounting Type Cam Followers	CF-SFU...B	$d_1 \leq 10$	○ ⁽³⁾	-	-	
		$10 < d_1$	○ ⁽⁵⁾	-	-	
Cam Follower G	CF...G		-	-	-	
C-Lube Cam Followers	CF...WB.../SG		-	-	-	
Miniature Type Cam Followers	CFS		-	-	-	
	CFS...W					
Cylindrical Roller Cam Followers	NUCF...B	$d_1 \leq 10$	○ ⁽³⁾	-	-	
		$10 < d_1$	○ ⁽²⁾	○	○	
	CR...B	With hexagon hole	$d_1 \leq 6.35$	-	-	-
		With screwdriver slot	$6.35 < d_1$	-	○	○
CRH...B	With hexagon hole	$d_1 \leq 6.35$	○	-	-	
	With screwdriver slot	$6.35 < d_1$	○	○	○	
		$d_1 \leq 7.938$	-	-	-	
		$7.938 < d_1$	-	○	○	

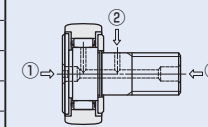

Notes⁽¹⁾ In case of Eccentric Type Cam Followers, thread diameter G shown in the table of dimensions is applicable in place of stud dia. and the oil hole on the outer surface of the stud cannot be used.

⁽²⁾ Grease nipple is incorporated in the hexagon hole. Re-greasing can be made from the stud head and the stud end by press fitting a supplied grease nipple into the stud end. See page 14.

⁽³⁾ Re-lubrication can be made from the re-greasing fitting that is inserted into the hexagon hole. See page 14.

⁽⁴⁾ Tapped holes for oil connectors are provided at the stud end and hole of the head.

⁽⁵⁾ Re-greasing can be made from the grease nipple in the hexagon hole.

I
CF
CFKR
CFS
NUCF
CR

Table 12 Type and Dimension of Lubrication Nozzles

Type	Dimension	Applicable grease nipple and re-grease fitting
A-5126T		NPF3 ⁽¹⁾ NPF6-1 ⁽¹⁾ Re-grease fitting ⁽¹⁾
A-5120R		NPF4-1 ⁽¹⁾ NPF6-1 ⁽¹⁾
B-5120R		
A-5120V		NPT4-1 NPT6-1 NPB2 NPB3 NPB3-1 NPB4
A-5240V		
B-5120V		
B-5240V		

Note⁽¹⁾ HSP-3(Yamada Corporation)can be used for them.

Remark The above nozzles can be attached on the standard grease gun shown below.
If required, please consult to IKO with type of lubrication nozzle.

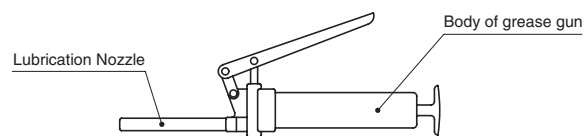

Accessories

Cam Follower accessories are shown in Table 13. Grease nipple dimensions are shown in Table 14 and Table 15. Dimensions of plug for unused oil hole and dimensions of plug inserter are shown in Table 16. Nut dimensions are shown in Table 17 and Table 18.

Table 13 Accessories

Series ⁽¹⁾ Size of stud dia. d_1 mm		Accessories	Grease nipple	Plug	Nut	Spring washer
Standard Type Cam Follower	CF...B	$d_1 \leq 10$	—	—	○	— ⁽²⁾
Eccentric Type Cam Followers	CFE...B		○	—	○	— ⁽²⁾
Solid Eccentric Stud Type Cam Followers	CFES...B	$10 < d_1$	○	—	○	— ⁽²⁾
Thrust Disk Type Cam Followers	CF...WB		○	—	○	— ⁽²⁾
Standard Type Cam Follower	CFKR	—	○	—	○	— ⁽²⁾
Eccentric Type Cam Followers	CFKRE		—	—	○	—
Centralized Lubrication Type Cam Followers	CF-RU1, CF-FU1	—	—	○	—	
Easy Mounting Type Cam Followers	CF-SFU...B	—	—	—	—	
Cam Follower G	CF...G	—	—	○	—	
C-Lube Cam Followers	CF...WB.../SG	—	—	○	—	
Miniature Type Cam Followers	CFS, CFS...W	—	—	○	—	
Cylindrical Roller Cam Followers	NUCF...B	$d_1 \leq 10$	—	—	○	—
		$10 < d_1$	○	—	○	—
Inch series Cam Followers	CR...B With hexagon hole	$d_1 \leq 6.35$	—	—	○	—
		$6.35 < d_1$	○	○	○	—
	CR With screwdriver slot	—	○	○	○	—
CRH...B With hexagon hole	—	$d_1 \leq 7.938$	—	—	○	—
		$7.938 < d_1$	○	○	○	—

Notes⁽¹⁾ For Eccentric Type Cam Follower, thread diameter G is applied.

⁽²⁾ Eccentric Type Cam Followers are supplied with spring washers.

Remark: The standard grease nipple (brass) is included in the Stainless Steel Made Cam Follower. When a stainless steel grease nipple is required, please contact IKO.

Table 14 Dimensions of grease nipple for Standard Type Cam Followers⁽¹⁾

Identification number	Dimensions of grease nipple mm				Stud diameter d_1 ⁽²⁾ mm	Dimension of inserter mm $d_0^{+0.05/-0.05}$
	d	D	L	W		
NPF3 ⁽³⁾	3	4	4.5	1.3	10	4.1
NPF4-1	4	5	5	1.5	12~16	5.3
NPF6-1	6	7	8	2	18~30	7.3

Notes⁽¹⁾ Applicable to Cam Followers other than Inch series Cam Followers.

⁽²⁾ For Eccentric Type Cam Followers, thread diameter G as shown in the dimension table is applicable.

⁽³⁾ Only applicable to Standard Type Cam Follower CFKR, and Eccentric Type Cam Follower CFKRE sizes 22 and 26.

Remark: The same grease nipple as the accessory is integrated in the hexagon hole on the head.

Table 15 Dimensions of grease nipple for Inch series Cam Followers

Identification number	Dimensions mm						Applicable Cam Followers
	<i>d</i>	<i>D</i>	<i>D</i> ₁	<i>L</i>	<i>L</i> ₁	<i>W</i>	
NPB2	3.18	7.5	6	9	5.5	1.5	CR8 ~ CR10-1, CRH8-1 ~ CRH11
NPB3	4.76	7.5	6	10	5.5	1.5	CR12 ~ CR22, CRH12 ~ CRH22
NPB3-1	4.76	7.5	6	12.5	5.5	1.55	CR24 ~ CR36, CRH24 ~ CRH44
NPB4	6.35	8	6	13	6	2	CR48, CRH48 ~ CRH64

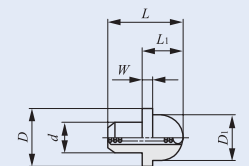
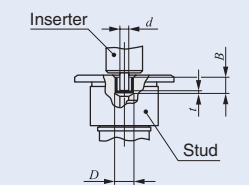

Table 16 Dimensions of plug for Inch series Cam Followers

Identification number	Dimensions of plug mm			Dimension of inserter mm	Applicable bearings (1)
	<i>D</i>	<i>t</i>	<i>B</i>		
USB2F	3.18	0.3	3.3	2.3	CR 8 ~ CR10-1
USB3F	4.76	0.4	4.3	3.7	CR12~CR36, CRH12 ~ CRH44
USB4F	6.35	0.5	4.8	5.2	CR48, CRH48~CRH64



Note(1) Shows representative types.

Table 17 Metric series nut dimensions

Model of bearing	Stud diameter <i>d</i> ₁ (1)	Nut dimensions mm			
		<i>G</i>	<i>m</i>	<i>s</i>	<i>e</i>
CF CFKR CFES CFE CFKRE CF...W CF-RU1 CF-FU1 CF...G CF...WB.../SG CFS CFS...W NUCF...B	1.4	M 1.4x0.3	1.1	3	3.25
	2	M 2 x0.4	1.6	4	4.6
	2.5	M 2.5x0.45	2	5	5.8
	3	M 3 x0.5	2.4	5.5	6.4
	4	M 4 x0.7	3.2	7	8.1
	5	M 5 x0.8	4	8	9.2
	6	M 6 x1	5	10	11.5
	8	M 8 x1.25	6.5	13	15
	10	M10 x1.0(2) M10 x1.25	8	17	19.6
	12	M12 x1.5	10	19	21.9
	16	M16 x1.5	13	24	27.7
	18	M18 x1.5	15	27	31.2
20	M20 x1.5	16	30	34.6	
24	M24 x1.5	19	36	41.6	
30	M30 x1.5	24	46	53.1	

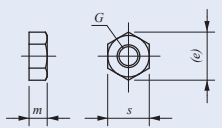

Note(1) For Eccentric Type Cam Followers, thread diameter *G* as shown in the dimension table is applicable.

Note(2) Applicable to Standard Type Cam Follower CFKR, and Eccentric Type Cam Follower CFKRE.

Table 18 Inch series nut dimensions

Model of bearing	Stud diameter <i>d</i> ₁ (inch)	Nut dimensions mm			
		<i>G</i> UNF	<i>m</i>	<i>s</i>	<i>e</i>
CR CRH	4.826	No.10-32	4	8	9.2
	6.35 (1/4)	1/4-28	5.5	10	11.5
	7.938 (5/16)	5/16-24	6.5	12	13.8
	9.525 (3/8)	3/8-24	8	14	16.2
	11.112 (7/16)	7/16-20	10	17	19.5
	12.7 (1/2)	1/2-20	11	19	21.9
	15.875 (5/8)	5/8-18	14	23	26.5
	19.05 (3/4)	3/4-16	16	26	30
	22.225 (7/8)	7/8-14	19	32	37
	25.4 (1)	1 -14UNS	22	36	41.4
	28.575 (1 1/8)	1 1/8-12	24	41	47.1
	31.75 (1 1/4)	1 1/4-12	27	46	53.5
	38.1 (1 1/2)	1 1/2-12	33	55	63.5
	44.45 (1 3/4)	1 3/4-12UN	38	65	75.1
	50.8 (2)	2 -12UN	44	75	86.6

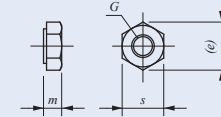

Special Specification

The grease nipple supplied with Metric series Cam Follower with hexagon socket as an accessory may be replaced with the NPT type grease nipple indicated in Table 19 upon your request. If required, please order with supplemental code, "/NP" at the end of identification number.

Example of Identification Number
CF 12 BUU / NP

Table 19 Dimension of NPT type grease nipple

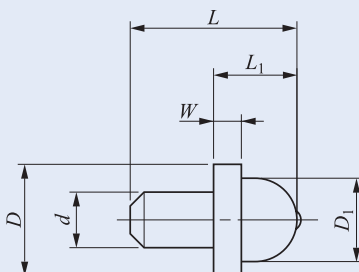

Code number	Dimension of grease nipple mm						Size of stud dia. <i>d</i> ₁ (1) mm
	<i>d</i>	<i>D</i>	<i>D</i> ₁	<i>L</i>	<i>L</i> ₁	<i>W</i>	
NPT4-1	4	8	6	12	6	2	12 ~ 16
NPT6-1	6	8	6	14	8	4	18 ~ 30

Note(1) For Eccentric Type Cam Follower CFE, thread diameter *G* is applied.

Remark Not applicable to Standard Type Cam Follower CFKR, and Eccentric Type Cam Follower CFKRE.

Table 20 Dimension of assembled NPT type grease nipple

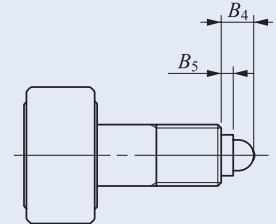

Code number	Dimension mm		Size of stud dia. <i>d</i> ₁ (1) mm
	<i>B</i> ₄	<i>B</i> ₅	
NPT4-1	6	2	12 ~ 16
NPT6-1	8	4	18 ~ 30

Note(1) For Eccentric Type Cam Follower CFE, thread diameter *G* is applied.

CF
CFKR
CFS
NUCF
CR

Mounting

- 1 Make the center axis of the mounting hole perpendicular to the moving direction of the Cam Follower and match the side shoulder accurately with the seating surface indicated by dimension f in the table of dimensions. (See Fig. 1)

The chamfered mounting hole should be as small as possible (C0.5 or so).

When mounting Cam Followers, do not hit the flange head of the Cam Follower directly with a hammer, etc. This may lead to a bearing failure such as irregular rotation or cracking.

If the Cam Follower outer ring is not in good contact with the mating running surface then we recommend use of a crowned outer ring type.

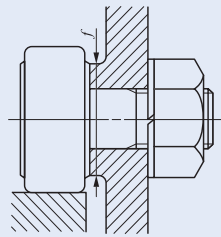

Fig. 1 Seating surface

- 2 The IKO mark on the flange head of the stud indicates the position of the oil hole on the raceway. Avoid locating the oil hole within the loading zone. This may lead to a short bearing life. (See Fig. 2.) The hole located in the middle part of the stud perpendicular to the stud center axis is used for greasing or locking.

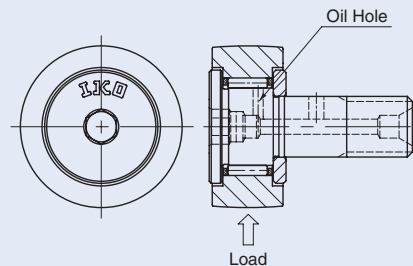

Fig. 2 Oil hole position and loading direction

- 3 When mounting Cam Followers, fix in place by holding the hexagon hole or screwdriver slot with a hex wrench or slotted screwdriver and use a wrench to tighten on a nut. (See Fig. 3)

If mounting by turning the hexagon hole or screwdriver slot itself, the hexagon hole or screwdriver slot of the Cam Follower may become damaged.

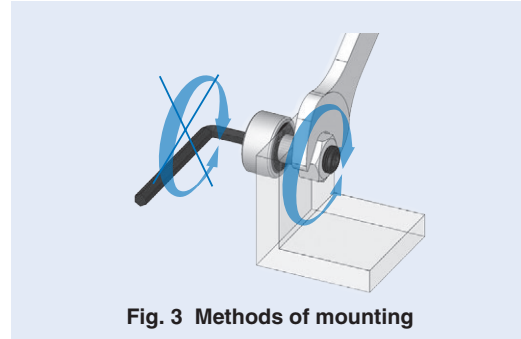

Fig. 3 Methods of mounting

- 4 When tightening the nut, the tightening torque should not exceed the values shown in the table of dimensions. If the tightening torque is too large, it is possible that the threaded portion of the stud will be broken. When there is a possibility of loosening, a special nut such as a lock nut, spring washer, or self-locking nut should be used.

- 5 When direct-fixing the Cam Follower without nuts for mounting as shown in Fig. 4, it may be difficult to achieve sufficient tightening torque. If the screw then loosens, stress may concentrate on the thread, causing the stud to break. Such a method is not recommended.

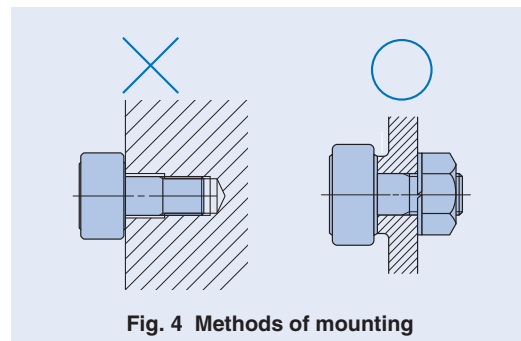

Fig. 4 Methods of mounting

- 6 Solid Eccentric Stud Type Cam Followers and Eccentric Type Cam Followers, are mounted in reference position where IKO mark on the head of stud is located as Fig.5. The outer ring position can be adjusted appropriately by turning the stud with a screwdriver or hexagon bar wrench using the screwdriver slot or hexagon hole of the stud head. The stud is fixed with a nut and a spring washer, etc. The tightening torque should not exceed the values of maximum tightening torque shown in the table of dimensions.

When shock loads are applied and the adjusted eccentricity has to be ensured, it is recommended to make holes in the housing, stud and eccentric collar, and fix the stud with a dowel pin as shown in Fig. 6. However, when the stud diameter is less than 8 mm (Eccentric collar diameter 11 mm), it is difficult to make a hole in the stud because the stud is through-hardened.

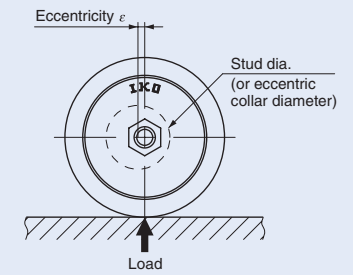

Fig. 5 Reference position for adjusting of Solid Eccentric Stud Type Cam Followers and Eccentric Type Cam Followers

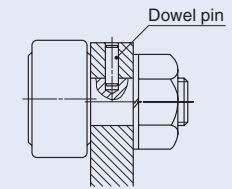

Fig. 6 Mounting example of Solid Eccentric Stud Type Cam Follower

Operating Temperature Range

Operating temperature range of Cam Followers is -20°C ~ +120°C. However, note that the maximum allowable temperature varies in models shown in Table 21.

Table 21 Limitation of operating temperature range

Model Stud diameter d_1 mm	Item	With cage		Full complement ThrustDisk Seals™
		Shield type	Sealed type	
Miniature Type Cam Followers CFS Thrust Disk Type Miniature Cam Followers CFS ... W	$d_1 = 2$	-20°C ~ 110°C ⁽¹⁾	-	-
Standard Type Cam Followers CF ... B Thrust Disk Type Cam Followers CF ... WB	$d_1 = 3, 4$	-20°C ~ 110°C ⁽¹⁾	-20°C ~ 80°C	-
	$d_1 = 5$	-20°C ~ 120°C	-	-
Standard Type Cam Followers / Stainless Steel Made CF ... FB Thrust Disk Type Cam Followers / Stainless Steel Made CF ... FWB	$3 \leq d_1 \leq 5$	-20°C ~ 110°C ⁽¹⁾	-20°C ~ 80°C	-
C-Lube Cam Followers CF ... WB ... /SG	$5 \leq d_1 \leq 20$	-	-15°C ~ 80°C ⁽²⁾	-
Inch Series Cam Followers ThrustDisk Seals™ CR ... VBS	$4.826 \leq d_1 \leq 22.225$	-	-	-20°C ~ 80°C

Notes⁽¹⁾ 100°C when used continuously.

⁽²⁾ Below 60°C is recommended for long use.

⑦ The length of a mounting hole for Eccentric Type Cam Followers must be at least that of the S dimension in Fig. 7.

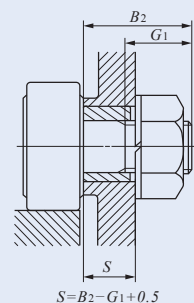
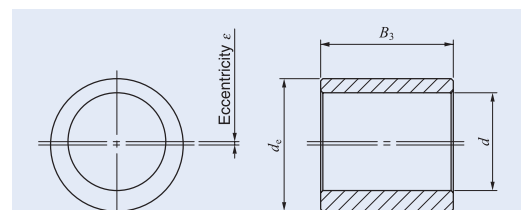

Fig. 7 Length of the mounting hole of Eccentric Type Cam Follower

⑧ Eccentric collar is available for Inch series Cam Followers.

Cam Followers with Eccentric collars, CRE are also available. If required, please consult with IKO.

Table 20 Eccentric collars for Inch series Cam Followers



unit: mm

Identical number of collar	Outer diameter of collar d_{ϵ}	Length of collar B_3	Eccentricity ϵ	Stud dia. d	Applicable Cam Followers
EB 8	6.350 (1/4)	6.350 (1/4)	0.250	4.826	CR 8 CR 8-1 (V)(B)(UU)(R)
EB10	9.525 (3/8)	9.525 (3/8)	0.380	6.350 (1/4)	CR10 CR10-1 (V)(B)(UU)(R)
EB12	12.700 (1/2)	12.700 (1/2)	0.380	9.525 (3/8)	CR12 CR14 (V)(B)(UU)(R)
EB16	15.875 (5/8)	15.875 (5/8)	0.760	11.112 (7/16)	CR16 CR18 (V)(B)(UU)(R)
EB20	17.450	17.450	0.760	12.700 (1/2)	CR20 CR22 (V)(B)(UU)(R)
EB24	22.225 (7/8)	22.225 (7/8)	0.760	15.875 (5/8)	CR24 CR26 (V)(B)(UU)(R)
EB28	25.400 (1)	25.400 (1)	0.760	19.050 (3/4)	CR28 CR30 (V)(B)(UU)(R)
EB32	30.150	30.150	0.760	22.225 (7/8)	CR32 CR36 (V)(B)(UU)(R)
EB48	44.450 (1 3/4)	44.450 (1 3/4)	1.520	31.750 (1 1/4)	CR48 VUU

⑨ For mounting Easy Mounting Type Cam Followers, it is recommended to fix the fixing screw from the upper side to the stepped portion of the stud. (See Fig. 8.)

While M5 - M6 screws are generally used as fixing screws, adjust the size used depending on the usage criteria.

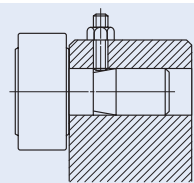

Fig. 8 Mounting example of Easy Mounting Type Cam Follower

Precaution For Use

① Do not wash C-Lube Cam Follower with organic solvent and/or white kerosene, which have the ability of removing fat nor leave them in contact with the above agents.

② To ensure normal rotation of the C-Lube Cam Follower, apply a load of 1% or over of the dynamic load rating at use.

Option Parts

C-Lube Unit for Cam Followers

Structure and features

IKO C-Lube unit for Cam Follower is a lubrication part to be mounted on the Cam Follower and its integral capillary lubricating element has a lot of lubrication oil impregnated in it.

The capillary lubricating element is consecutive porous resin formed by sinter molding of fine resin powder and a lot of lubrication oil is impregnated in it by using the capillary action that occurs within the internal space.

Regular lubrication is not needed as lubrication oil is supplied onto the outside diameter surface of the outer ring and mating guide surface (cam guide surface). The grease is not scattered and contamination of the surrounding environment is prevented.

The combination with IKO C-Lube cam follower (See Page 155) realizes maintenance-free cam follower inside and cam guide surface.

Structure of C-Lube Unit for Cam Followers

IKO C-Lube Cam Follower

Magnified photos of C-Lube

Before impregnating oil

Resin particles are strongly fusion bonded.

After impregnating oil

Lubricant is retained in cavities amongst resin particles.

Identification number

The identification number example of IKO C-Lube Unit is shown below.

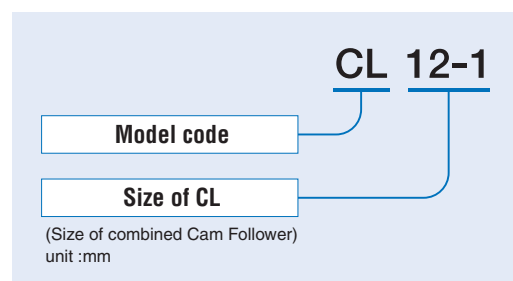

Allowable Rotational speed

The Rotational speed of IKO Cam Follower with C-Lube Unit should not exceeded $d_1 n = 10,000$ for reference.

$$d_1 n = d_1 \times n$$

d_1 : Stud diameter of Cam Follower, mm
 n : Rotational speed, min^{-1}

Minimum rotational angle

Lubricating oil is supplied to the whole external diameter surface of the outer ring. Accordingly, use the product in a condition in which the outer ring makes one or more turns.

Operating temperature

Allowable operating temperature range of IKO Cam Follower with C-Lube Unit is -15 to 80°C.

I
CF
CFKR
CFS
NUCF
CR

Mounting

- 1 Set the C-Lube Unit perpendicularly to the center axis of Cam Follower and fix together with Cam Follower by tightening nut. (See Fig. 9.)

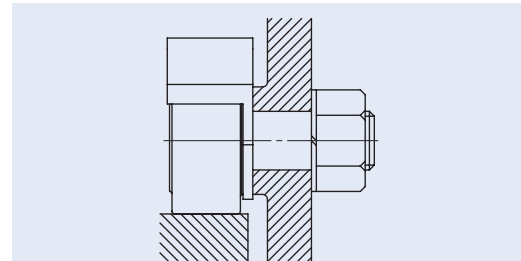

Fig. 9 Mounting of C-Lube Unit

- 2 Position of C-Lube Unit is adjustable. C-Lube Unit must be positioned avoiding loading direction. (See Fig. 10.)

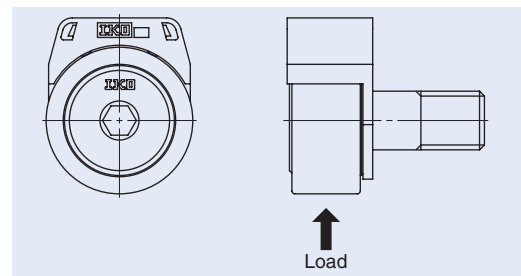

Fig. 10 Load direction of Cam Follower

- 3 When tightening the nut, the tightening torque should not be exceeded the value maximum tightening torque on dimension table. In case loosening of the nut is predicted due to vibration, using lock nut, spring washer and other special washer are recommended.

Precaution for use

- 1 Do not wash with organic solvent and/or white kerosene, which have the ability of removing fat nor leave them in contact with the above agents.
- 2 Do not apply a load onto the C-Lube Unit directly.
- 3 To ensure normal rotation of the Cam Follower, apply a load of 1% or over of the dynamic load rating at use. Also, the outer ring needs to be rotate over a revolution to supply lubricant on entire outer diameter surface.
- 4 The maximum allowable load on IKO Cam Follower with C-Lube Unit is, 80% of the maximum allowable load of the needle bearing. C-Lube Unit may be damaged and influenced to the smooth rotation and lubricating performance by excessive load.
- 5 After assembling C-Lube Unit and Cam Followers in the machine, please confirm that C-Lube unit provides oil correctly to the cam guide surface before actual operation.
- 6 Do not use in the environment which contamination of liquid and/or harmful foreign matter are expected.
- 7 Replace with new C-Lube Unit when inside oil finishes completely. Re-lubrication is not possible.

Table 21 Dimensions of C-Lube Unit for Cam Followers

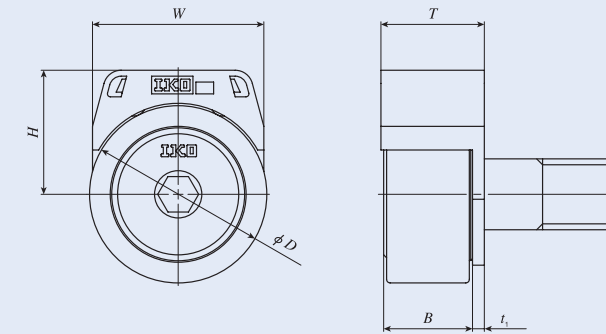

Model number	Boundary Dimensions mm				Applicable Cam Followers		
	W	H	T	t ₁	Model number (1)	Boundary Dimensions mm	
						D	B
CL 5	12.4	10.7	12.1	1.5	CF 5 B	13	10
CL 6	15.4	12.6	14	1.5	CF 6 B	16	12.2 max
CL 8	18.4	14.2	14	1.5	CF 8 B	19	12.2 max
CL 10	21	17	15.5	2	CF 10 B CFKR 22	22	13.2 max
CL 10-1	21	19.2	15.5	2	CF 10-1 B CFKR 26	26	13.2 max
CL 12	29	21	17.5	2	CF 12 B CFKR 30	30	15.2 max
CL 12-1	29	22	17.5	2	CF 12-1 B CFKR 32	32	15.2 max
CL 16	33.8	27.4	23.4	2.5	CF 16 B CFKR 35	35	19.6 max
CL 18	38.8	30.4	25.4	2.5	CF 18 B CFKR 40	40	21.6 max
CL 20	45.8	38.4	29.9	3	CF 20 B CFKR 52	52	25.6 max
CL 20-1	45.8	35.4	29.9	3	CF 20-1 B CFKR 47	47	25.6 max

Note(1) Only representative identification numbers are shown in the table, but applicable to all Cam Followers other than Miniature Type Cam Followers and Inch Series Cam Followers.

It is recommended to use together with C-Lube Cam Followers in order to make maintenance-free more effective.

Remark Load on the Cam Follower with the C-Lube unit equipped must be up to 80% of the maximum allowable static load of the Cam Follower to be combined. For the maximum allowed static load of each Cam Follower, please see the dimension tables of respective models.

I
CF
CFKR
CFS
NUCF
CR

Option Parts

Way for Cam Follower

The accuracy of the mating cam guide that comes in contact with the outer ring of Cam Followers has a large influence on the guide performance of Cam Followers and machinery.

A specially designed high-precision Way for Cam Follower should be used in order to achieve sufficient performance from the Cam Followers. Fixed with bolts for simple assembly and available in 2 models - A type or B type - depending on the mounting direction.

Identification number

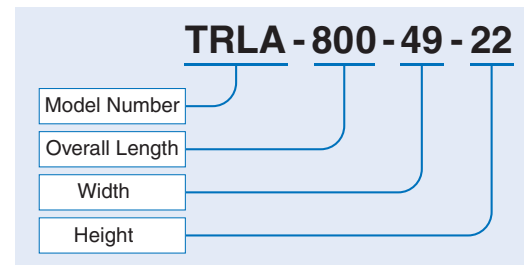

Model Types

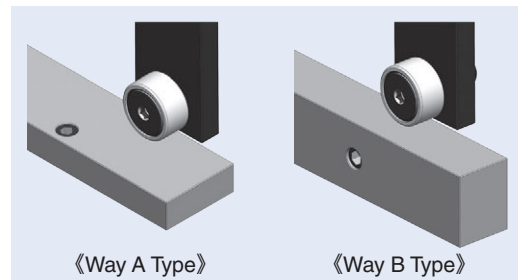
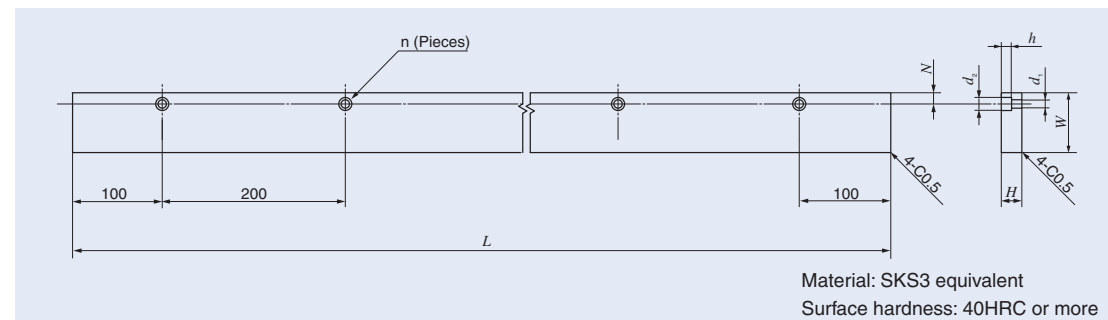

Table of Dimensions

Way A Type



Identification number	Boundary Dimensions mm							Applicable Cam Followers
	$L(n)$	W	H	N	d_1	d_2	h	
TRLA- 600-40-22	600(3)	40						Stud dia. 3~ 8mm
TRLA- 800-40-22	800(4)							
TRLA-1000-40-22	1000(5)							
TRLA- 600-49-22	600(3)	49	22	12	9	14	11	Stud dia.10~18mm
TRLA- 800-49-22	800(4)							
TRLA-1000-49-22	1000(5)							
TRLA- 600-64-22	600(3)	64						Stud dia.20~30mm
TRLA- 800-64-22	800(4)							
TRLA-1000-64-22	1000(5)							

Remark For other dimensions, please contact IKO.

Way B Type

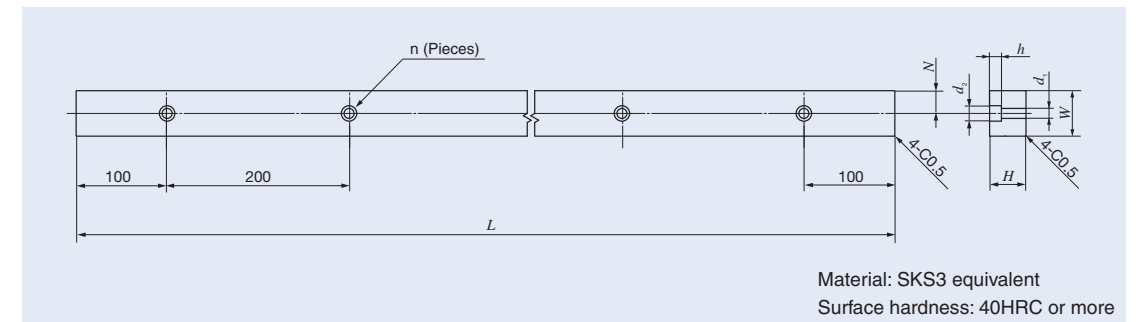

Identification number	Boundary Dimensions mm							Applicable Cam Followers
	$L(n)$	W	H	N	d_1	d_2	h	
TRLB- 600-34-22	600(3)	34	22	17	9	14	11	Stud dia. 3~12mm
TRLB- 800-34-22	800(4)							
TRLB-1000-34-22	1000(5)							
TRLB- 600-50-40	600(3)	50	40	25	11	17	13	Stud dia.16~30mm
TRLB- 800-50-40	800(4)							
TRLB-1000-50-40	1000(5)							

Remark For other dimensions, please contact IKO.

Introduction of Special Support Examples

Introducing special support examples for Ways for Cam Follower.

A variety of shapes are supported in addition to the special support examples. For details, please contact IKO.

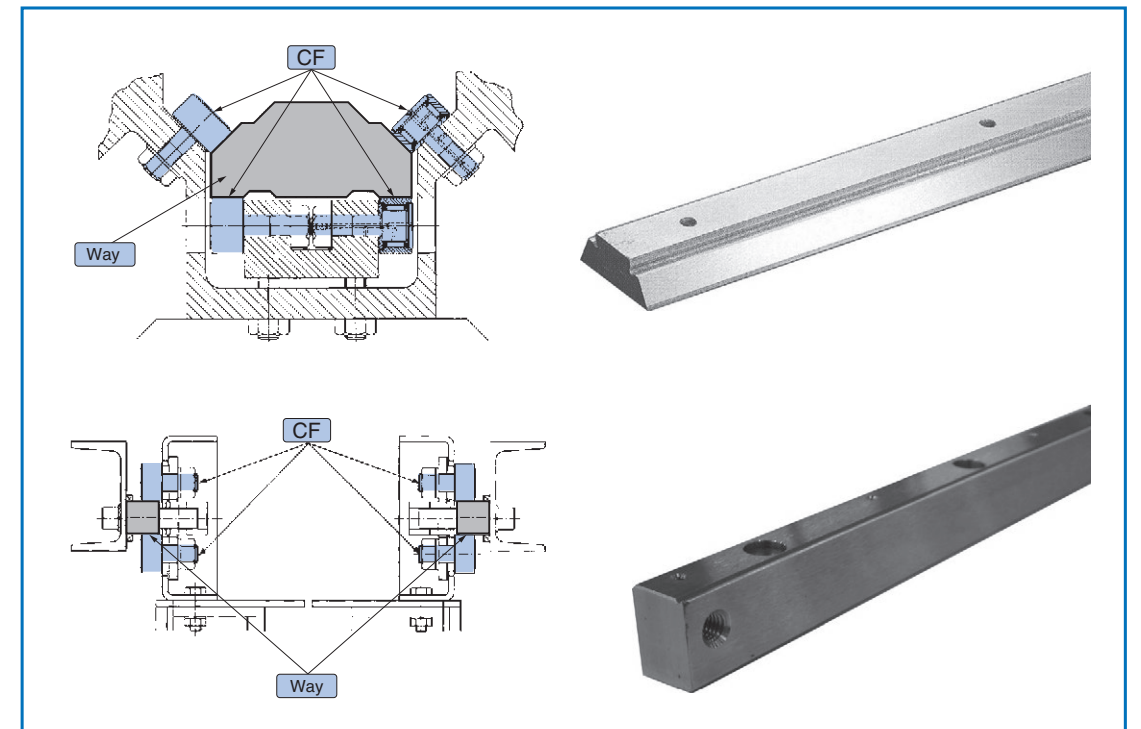

CF
CFKR
CFS
NUCF
CR

CAM FOLLOWERS

Standard Type Cam Followers CF...B With Cage/Stud Head Hex Hole

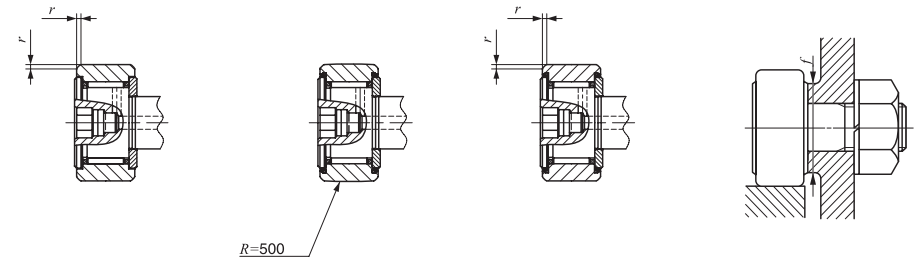
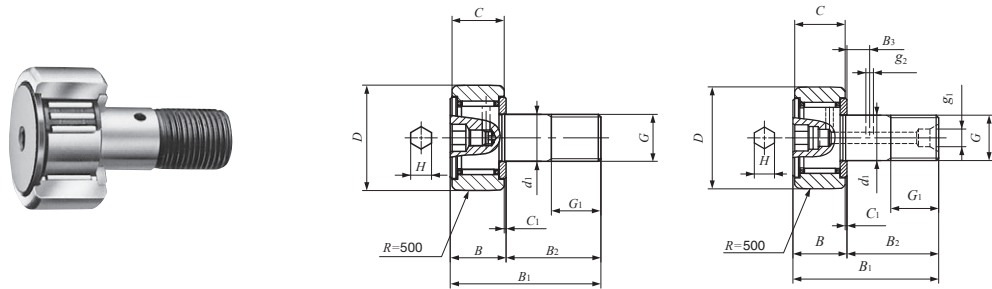

Stud dia. 3—30mm

CF...BR Stud dia d_1 3-10mm

CF...BR Stud dia d_1 12-30mm

Stud dia. mm	Identification number				Mass (Ref.) g	Boundary dimensions mm			
	Shield type		Sealed type			D	C	d_1	G
	With crowned outer ring	With cylindrical outer ring	With crowned outer ring	With cylindrical outer ring					
3	CF 3 BR	CF 3 B	CF 3 BUUR	CF 3 BUU	4.3	10	7	3	M 3×0.5
4	CF 4 BR	CF 4 B	CF 4 BUUR	CF 4 BUU	7.4	12	8	4	M 4×0.7
5	CF 5 BR	CF 5 B	CF 5 BUUR	CF 5 BUU	10.3	13	9	5	M 5×0.8
6	CF 6 BR	CF 6 B	CF 6 BUUR	CF 6 BUU	18.5	16	11	6	M 6×1
8	CF 8 BR	CF 8 B	CF 8 BUUR	CF 8 BUU	28.5	19	11	8	M 8×1.25
	CF 8 BRM	CF 8 BM	CF 8 BUURM	CF 8 BUUM	28.5	19	11	8	M 8×1
10	CF 10 BR	CF 10 B	CF 10 BUUR	CF 10 BUU	45	22	12	10	M10×1.25
	CF 10 BRM	CF 10 BM	CF 10 BUURM	CF 10 BUUM	45	22	12	10	M10×1
	CF 10-1 BR	CF 10-1 B	CF 10-1 BUUR	CF 10-1 BUU	60	26	12	10	M10×1.25
	CF 10-1 BRM	CF 10-1 BM	CF 10-1 BUURM	CF 10-1 BUUM	60	26	12	10	M10×1
12	CF 12 BR	CF 12 B	CF 12 BUUR	CF 12 BUU	95	30	14	12	M12×1.5
	CF 12-1 BR	CF 12-1 B	CF 12-1 BUUR	CF 12-1 BUU	105	32	14	12	M12×1.5
16	CF 16 BR	CF 16 B	CF 16 BUUR	CF 16 BUU	170	35	18	16	M16×1.5
18	CF 18 BR	CF 18 B	CF 18 BUUR	CF 18 BUU	250	40	20	18	M18×1.5
20	CF 20 BR	CF 20 B	CF 20 BUUR	CF 20 BUU	460	52	24	20	M20×1.5
	CF 20-1 BR	CF 20-1 B	CF 20-1 BUUR	CF 20-1 BUU	385	47	24	20	M20×1.5
24	CF 24 BR	CF 24 B	CF 24 BUUR	CF 24 BUU	815	62	29	24	M24×1.5
	CF 24-1 BR	CF 24-1 B	CF 24-1 BUUR	CF 24-1 BUU	1 140	72	29	24	M24×1.5
30	CF 30 BR	CF 30 B	CF 30 BUUR	CF 30 BUU	1 870	80	35	30	M30×1.5
	CF 30-1 BR	CF 30-1 B	CF 30-1 BUUR	CF 30-1 BUU	2 030	85	35	30	M30×1.5
	CF 30-2 BR	CF 30-2 B	CF 30-2 BUUR	CF 30-2 BUU	2 220	90	35	30	M30×1.5

Note⁽¹⁾ Minimum allowable value of chamfer dimension r
 Remarks1. Models with a stud diameter d_1 of 4 mm or less have no oil hole. For models with a stud dia. 5 to 10mm, oil hole (re-greasing fitting) is provided at the head. Other models are provided with an oil hole (grease nipple) at the head and an oil hole each on the outside surface and end surface of the stud.
 2. Shield type models with a stud diameter d_1 of 10mm or less and the sealed type models are provided with prepacked grease. Other models are not provided with prepacked grease. Perform proper lubrication for use.

CF...B CF...BUUR CF...BUU

Boundary dimensions mm										Mounting dimension f Min. mm	Maximum tightening torque N-m	Basic dynamic load rating C N	Basic static load rating C_0 N	Maximum allowable static load N
G_1	B	B_1	B_2	B_3	C_1	g_1	g_2	H	r_s min ⁽¹⁾					
5	8	17	9	—	0.5	—	—	2	0.2	6.8	0.34	1 500	1 020	384
6	9	20	11	—	0.5	—	—	2.5	0.3	8.3	0.78	2 070	1 590	834
7.5	10	23	13	—	0.5	—	—	3	0.3	9.3	1.6	2 520	2 140	1 260
8	12.2max	28.2max	16	—	0.6	—	—	3	0.3	11	2.7	3 660	3 650	1 950
10	12.2max	32.2max	20	—	0.6	—	—	4	0.3	13	6.5	4 250	4 740	4 620
10	12.2max	32.2max	20	—	0.6	—	—	4	0.3	13	7.1	4 250	4 740	4 620
12	13.2max	36.2max	23	—	0.6	—	—	4	0.3	16	13.8	5 430	6 890	6 890
12	13.2max	36.2max	23	—	0.6	—	—	4	0.3	16	14.7	5 430	6 890	6 890
12	13.2max	36.2max	23	—	0.6	—	—	4	0.3	16	13.8	5 430	6 890	6 890
12	13.2max	36.2max	23	—	0.6	—	—	4	0.3	16	14.7	5 430	6 890	6 890
13	15.2max	40.2max	25	6	0.6	4	3	6	0.6	21	21.9	7 910	9 790	9 790
13	15.2max	40.2max	25	6	0.6	4	3	6	0.6	21	21.9	7 910	9 790	9 790
17	19.6max	52.1max	32.5	8	0.8	4	3	6	0.6	26	58.5	12 000	18 300	18 300
19	21.6max	58.1max	36.5	8	0.8	6	3	8	1	29	86.2	14 800	25 200	25 200
21	25.6max	66.1max	40.5	9	0.8	6	4	8	1	34	119	20 700	34 600	34 600
21	25.6max	66.1max	40.5	9	0.8	6	4	8	1	34	119	20 700	34 600	34 600
25	30.6max	80.1max	49.5	11	0.8	6	4	12	1	40	215	30 500	52 600	52 000
25	30.6max	80.1max	49.5	11	0.8	6	4	12	1	40	215	30 500	52 600	52 000
32	37 max	100 max	63	15	1	6	4	17	1	49	438	45 400	85 100	85 100
32	37 max	100 max	63	15	1	6	4	17	1	49	438	45 400	85 100	85 100
32	37 max	100 max	63	15	1	6	4	17	1	49	438	45 400	85 100	85 100

I
CF
CFKR
CFS
NUCF
CR

CAM FOLLOWERS

Standard Type Cam Followers CF...B Full Complement Type/Stud Head Hex Hole

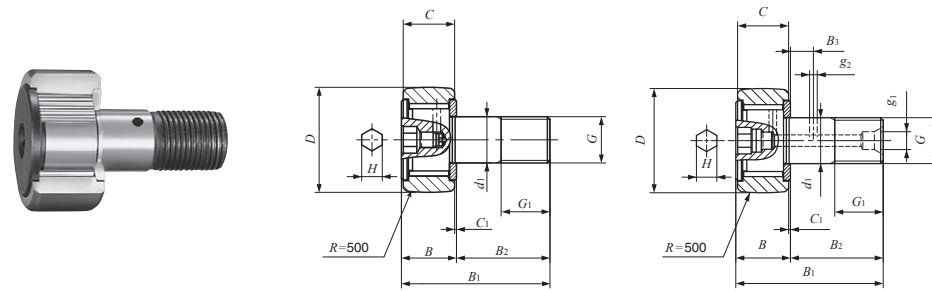

Stud dia. 6–30mm

CF...VBR
Stud dia. d_1 6-10mm

CF...VBR
Stud dia. d_1 12-30mm

Stud dia. mm	Identification number				Mass (Ref.) g	D	C	d_1
	Shield type		Sealed type					
	With crowned outer ring	With cylindrical outer ring	With crowned outer ring	With cylindrical outer ring				
6	CF 6 VBR	CF 6 VB	CF 6 VBUUR	CF 6 VBUU	19	16	11	6
8	CF 8 VBR	CF 8 VB	CF 8 VBUUR	CF 8 VBUU	29	19	11	8
	CF 8 VBRM	CF 8 VBM	CF 8 VBUURM	CF 8 VBUUM	29	19	11	8
10	CF 10 VBR	CF 10 VB	CF 10 VBUUR	CF 10 VBUU	46	22	12	10
	CF 10 VBRM	CF 10 VBM	CF 10 VBUURM	CF 10 VBUUM	46	22	12	10
	CF 10-1 VBR	CF 10-1 VB	CF 10-1 VBUUR	CF 10-1 VBUU	61	26	12	10
	CF 10-1 VBRM	CF 10-1 VBM	CF 10-1 VBUURM	CF 10-1 VBUUM	61	26	12	10
12	CF 12 VBR	CF 12 VB	CF 12 VBUUR	CF 12 VBUU	97	30	14	12
	CF 12-1 VBR	CF 12-1 VB	CF 12-1 VBUUR	CF 12-1 VBUU	107	32	14	12
16	CF 16 VBR	CF 16 VB	CF 16 VBUUR	CF 16 VBUU	173	35	18	16
18	CF 18 VBR	CF 18 VB	CF 18 VBUUR	CF 18 VBUU	255	40	20	18
20	CF 20 VBR	CF 20 VB	CF 20 VBUUR	CF 20 VBUU	465	52	24	20
	CF 20-1 VBR	CF 20-1 VB	CF 20-1 VBUUR	CF 20-1 VBUU	390	47	24	20
24	CF 24 VBR	CF 24 VB	CF 24 VBUUR	CF 24 VBUU	820	62	29	24
	CF 24-1 VBR	CF 24-1 VB	CF 24-1 VBUUR	CF 24-1 VBUU	1 140	72	29	24
30	CF 30 VBR	CF 30 VB	CF 30 VBUUR	CF 30 VBUU	1 870	80	35	30
	CF 30-1 VBR	CF 30-1 VB	CF 30-1 VBUUR	CF 30-1 VBUU	2 030	85	35	30
	CF 30-2 VBR	CF 30-2 VB	CF 30-2 VBUUR	CF 30-2 VBUU	2 220	90	35	30

Note⁽¹⁾ Minimum allowable value of chamfer dimension r

Remarks1. Models with a stud diameter d_1 of 10 mm or less have an oil hole (re-greasing fitting) at the head. Other models are provided with an oil hole (grease nipple) at the head and an oil hole each on the outside surface and end surface of the stud.

2. Provided with prepacked grease.

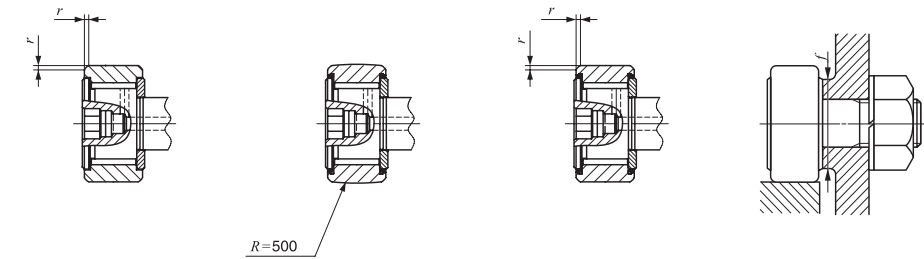

CF...VB

CF...VBUUR

CF...VBUU

Boundary dimensions mm	Mounting dimension											Maximum tightening torque N·m	Basic dynamic load rating C N	Basic static load rating C_0 N	Maximum allowable static load N
	G	G_1	B_{max}	B_{1max}	B_2	B_3	C_1	g_1	g_2	H	$r_{smin}^{(1)}$				
M 6×1	8	12.2	28.2	16	—	0.6	—	—	3	0.3	11	2.7	6 980	8 500	1 950
M 8×1.25	10	12.2	32.2	20	—	0.6	—	—	4	0.3	13	6.5	8 170	11 200	4 620
M 8×1	10	12.2	32.2	20	—	0.6	—	—	4	0.3	13	7.1	8 170	11 200	4 620
M10×1.25	12	13.2	36.2	23	—	0.6	—	—	4	0.3	16	13.8	9 570	14 500	8 650
M10×1	12	13.2	36.2	23	—	0.6	—	—	4	0.3	16	14.7	9 570	14 500	8 650
M10×1.25	12	13.2	36.2	23	—	0.6	—	—	4	0.3	16	13.8	9 570	14 500	8 650
M10×1	12	13.2	36.2	23	—	0.6	—	—	4	0.3	16	14.7	9 570	14 500	8 650
M12×1.5	13	15.2	40.2	25	6	0.6	4	3	6	0.6	21	21.9	13 500	19 700	13 200
M12×1.5	13	15.2	40.2	25	6	0.6	4	3	6	0.6	21	21.9	13 500	19 700	13 200
M16×1.5	17	19.6	52.1	32.5	8	0.8	4	3	6	0.6	26	58.5	20 700	37 600	23 200
M18×1.5	19	21.6	58.1	36.5	8	0.8	6	3	8	1	29	86.2	25 300	51 300	31 100
M20×1.5	21	25.6	66.1	40.5	9	0.8	6	4	8	1	34	119	33 200	64 500	37 500
M20×1.5	21	25.6	66.1	40.5	9	0.8	6	4	8	1	34	119	33 200	64 500	37 500
M24×1.5	25	30.6	80.1	49.5	11	0.8	6	4	12	1	40	215	46 600	92 000	52 000
M24×1.5	25	30.6	80.1	49.5	11	0.8	6	4	12	1	40	215	46 600	92 000	52 000
M30×1.5	32	37	100	63	15	1	6	4	17	1	49	438	67 700	144 000	85 900
M30×1.5	32	37	100	63	15	1	6	4	17	1	49	438	67 700	144 000	85 900
M30×1.5	32	37	100	63	15	1	6	4	17	1	49	438	67 700	144 000	85 900

I
CF
CFKR
CFS
NUCF
CR

CAM FOLLOWERS

Standard Type Cam Followers CF...B / Stainless Steel Made **With Cage/Stud Head Hex Hole**

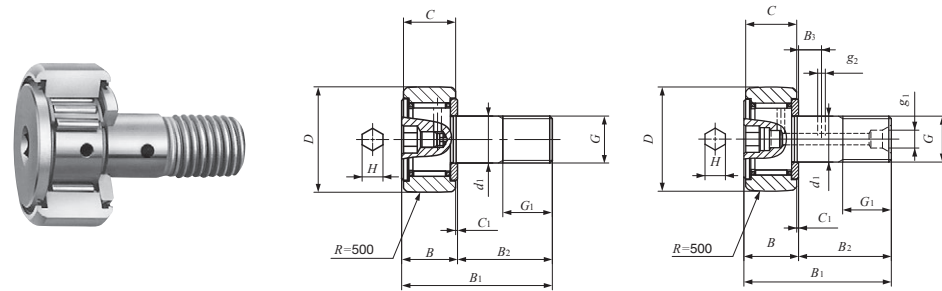

Stud dia. 3–20mm

CF...FBR
Stud dia. d_1 3-10mm

CF...FBR
Stud dia. d_1 12-20mm

Stud dia. mm	Identification number				Mass (Ref.) g	Boundary dimensions mm				
	Shield type		Sealed type			D	C	d_1	G	G_1
	With crowned outer ring	With cylindrical outer ring	With crowned outer ring	With cylindrical outer ring						
3	CF 3 FBR	CF 3 FB	CF 3 FBUUR	CF 3 FBUU	4.3	10	7	3	M 3×0.5	5
4	CF 4 FBR	CF 4 FB	CF 4 FBUUR	CF 4 FBUU	7.4	12	8	4	M 4×0.7	6
5	CF 5 FBR	CF 5 FB	CF 5 FBUUR	CF 5 FBUU	10.3	13	9	5	M 5×0.8	7.5
6	CF 6 FBR	CF 6 FB	CF 6 FBUUR	CF 6 FBUU	18.5	16	11	6	M 6×1	8
8	CF 8 FBR	CF 8 FB	CF 8 FBUUR	CF 8 FBUU	28.5	19	11	8	M 8×1.25	10
10	CF 10 FBR CF 10-1 FBR	CF 10 FB CF 10-1 FB	CF 10 FBUUR CF 10-1 FBUUR	CF 10 FBUU CF 10-1 FBUU	45 60	22 26	12	10	M10×1.25	12
12	CF 12 FBR CF 12-1 FBR	CF 12 FB CF 12-1 FB	CF 12 FBUUR CF 12-1 FBUUR	CF 12 FBUU CF 12-1 FBUU	95 105	30 32	14	12	M12×1.5	13
16	CF 16 FBR	CF 16 FB	CF 16 FBUUR	CF 16 FBUU	170	35	18	16	M16×1.5	17
18	CF 18 FBR	CF 18 FB	CF 18 FBUUR	CF 18 FBUU	250	40	20	18	M18×1.5	19
20	CF 20 FBR CF 20-1 FBR	CF 20 FB CF 20-1 FB	CF 20 FBUUR CF 20-1 FBUUR	CF 20 FBUU CF 20-1 FBUU	460 385	52 47	24	20	M20×1.5	21

Note⁽¹⁾ Minimum allowable value of chamfer dimension r
 Remarks1. Models with a stud diameter d_1 of 4 mm or less have no oil hole. For models with a stud dia. 5 to 10 mm, oil hole (re-greasing fitting) is provided at the head. Other models are provided with an oil hole (grease nipple) at the head and an oil hole each on the outside surface and end surface of the stud.
 2. Shield type models with a stud diameter d_1 of 10 mm or less and the sealed type models are provided with prepacked grease. Other models are not provided with prepacked grease. Perform proper lubrication for use.

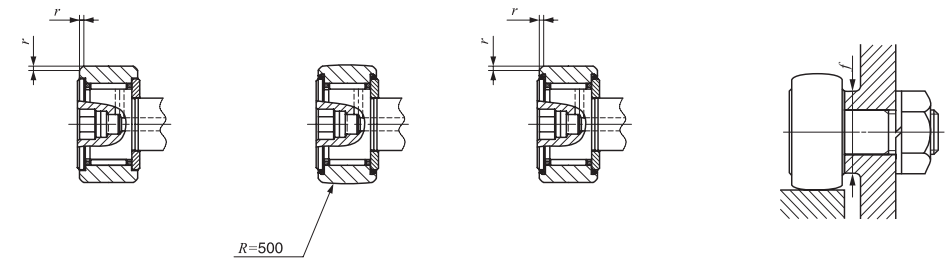

CF...FB

CF...FBUUR

CF...FBUU

Boundary dimensions mm										Mounting dimension f Min. mm	Maximum tightening torque N-m	Basic dynamic load rating C N	Basic static load rating C_0 N	Maximum allowable static load N
B	B_1	B_2	B_3	C_1	g_1	g_2	H	$r_{s \min}^{(1)}$						
8	17	9	—	0.5	—	—	2	0.2	6.8	0.34	1 200	813	384	
9	20	11	—	0.5	—	—	2.5	0.3	8.3	0.78	1 650	1 270	834	
10	23	13	—	0.5	—	—	3	0.3	9.3	1.6	1 930	1 730	1 260	
12.2 max	28.2 max	16	—	0.6	—	—	3	0.3	11	2.7	2 930	2 920	1 950	
12.2 max	32.2 max	20	—	0.6	—	—	4	0.3	13	6.5	3 400	3 790	3 790	
13.2 max	36.2 max	23	—	0.6	—	—	5	0.3	16	13.8	4 340	5 510	5 510	
15.2 max	40.2 max	25	6	0.6	4	3	6	0.6	21	21.9	6 330	7 830	7 830	
19.6 max	52.1 max	32.5	8	0.8	4	3	6	0.6	26	58.5	9 620	14 700	14 700	
21.6 max	58.1 max	36.5	8	0.8	6	3	8	1	29	86.2	11 800	20 200	20 200	
25.6 max	66.1 max	40.5	9	0.8	8	4	8	1	34	119	16 500	27 700	27 700	

I
CF
CFKR
CFS
NUCF
CR

Standard Type Cam Followers CFKR With Cage/Double Hex Hole

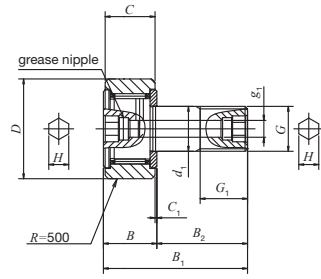

CFKR...R
Outside dia. of outer ring D 22, 26 mm

Stud dia. 10–30mm

Stud diameter mm	Identification number ⁽¹⁾				Mass (Ref.) g					
	Shield type		Sealed type			D	C	d ₁	G	G ₁
	Crowned outer ring	Cylindrical outer ring	Crowned outer ring	Cylindrical outer ring						
10	CFKR 22 R	CFKR 22	CFKR 22 UUR	CFKR 22 UU	43	22	12	10	M10×1.0	12
	CFKR 26 R	CFKR 26	CFKR 26 UUR	CFKR 26 UU	58	26	12	10	M10×1.0	12
12	CFKR 30 R	CFKR 30	CFKR 30 UUR	CFKR 30 UU	94	30	14	12	M12×1.5	13
	CFKR 32 R	CFKR 32	CFKR 32 UUR	CFKR 32 UU	104	32	14	12	M12×1.5	13
16	CFKR 35 R	CFKR 35	CFKR 35 UUR	CFKR 35 UU	165	35	18	16	M16×1.5	17
18	CFKR 40 R	CFKR 40	CFKR 40 UUR	CFKR 40 UU	248	40	20	18	M18×1.5	19
20	CFKR 47 R	CFKR 47	CFKR 47 UUR	CFKR 47 UU	378	47	24	20	M20×1.5	21
	CFKR 52 R	CFKR 52	CFKR 52 UUR	CFKR 52 UU	453	52	24	20	M20×1.5	21
24	CFKR 62 R	CFKR 62	CFKR 62 UUR	CFKR 62 UU	795	62	29	24	M24×1.5	25
	CFKR 72 R	CFKR 72	CFKR 72 UUR	CFKR 72 UU	1 120	72	29	24	M24×1.5	25
30	CFKR 80 R	CFKR 80	CFKR 80 UUR	CFKR 80 UU	1 860	80	35	30	M30×1.5	32
	CFKR 85 R	CFKR 85	CFKR 85 UUR	CFKR 85 UU	2 020	85	35	30	M30×1.5	32
	CFKR 90 R	CFKR 90	CFKR 90 UUR	CFKR 90 UU	2 210	90	35	30	M30×1.5	32

Note⁽¹⁾ The identification number indicates the outer ring outside diameter.

⁽²⁾ Minimum allowable value of chamfer dimension r.

Remark Grease is pre-packed if the stud diameter d₁ of the shield type is 10 mm or less or if the seal structure is the sealed type. Other models are not provided with pre-packed grease. Perform proper lubrication for use.

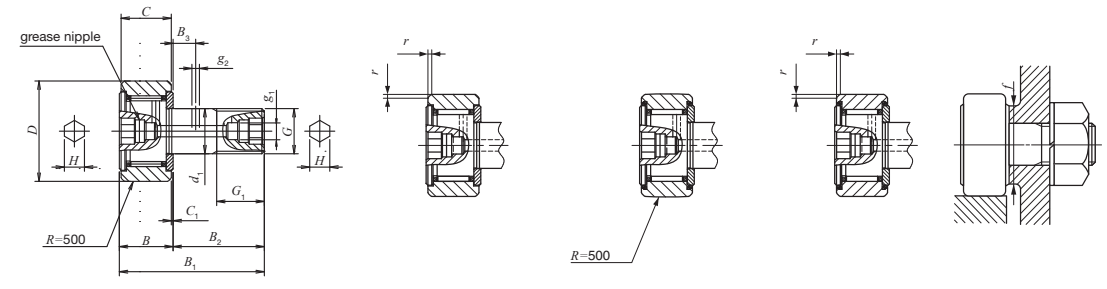

CFKR...R
Outside dia. of outer ring D 30 - 90 mm

CFKR CFKR...UUR CFKR...UU

Boundary dimensions mm									Mounting dimension f Min. mm	Maximum tightening torque N·m	Basic dynamic load rating C N	Basic static load rating C ₀ N	Maximum allowable static load N
B _{max}	B _{1max}	B ₂	B ₃	C ₁	g ₁	g ₂	H	r _{s min} ⁽²⁾					
13.2	36.2	23	—	0.6	3	—	5	0.3	16	13.0	5 430	6 890	6 890
15.2	40.2	25	6	0.6	4	3	6	0.6	21	21.9	7 910	9 790	9 790
19.6	52.1	32.5	8	0.8	4	3	8	0.6	26	58.5	12 000	18 300	18 300
21.6	58.1	36.5	8	0.8	6	3	8	1	29	86.2	14 800	25 200	25 200
25.6	66.1	40.5	9	0.8	6	4	10	1	34	119	20 700	34 600	34 600
30.6	80.1	49.5	11	0.8	6	4	14	1	40	215	30 500	52 600	52 000
37	100	63	15	1	6	4	14	1	49	438	45 400	85 100	85 100

I

CF
CFKR
CFS
NUCF
CR

Standard Type Cam Followers CFKR Full Complement Type/Stud Head Hex Hole

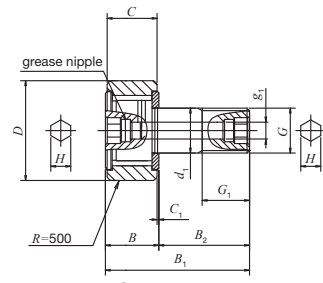
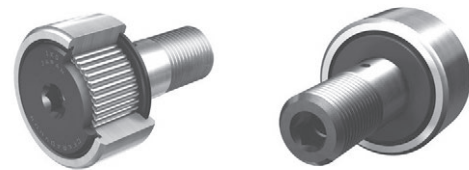

CFKR...VR
Outside dia. of outer ring D 22, 26 mm

Stud dia. 10 – 30mm

Stud diameter mm	Identification number ⁽¹⁾				Mass (Ref.) g	Boundary dimensions mm				
	Shield type		Sealed type			D	C	d ₁	G	G ₁
	Crowned outer ring	Cylindrical outer ring	Crowned outer ring	Cylindrical outer ring						
10	CFKR 22 VR	CFKR 22 V	CFKR 22 VUUR	CFKR 22 VUU	44	22	12	10	M10×1.0	12
	CFKR 26 VR	CFKR 26 V	CFKR 26 VUUR	CFKR 26 VUU	59	26	12	10	M10×1.0	12
12	CFKR 30 VR	CFKR 30 V	CFKR 30 VUUR	CFKR 30 VUU	96	30	14	12	M12×1.5	13
	CFKR 32 VR	CFKR 32 V	CFKR 32 VUUR	CFKR 32 VUU	106	32	14	12	M12×1.5	13
16	CFKR 35 VR	CFKR 35 V	CFKR 35 VUUR	CFKR 35 VUU	168	35	18	16	M16×1.5	17
18	CFKR 40 VR	CFKR 40 V	CFKR 40 VUUR	CFKR 40 VUU	253	40	20	18	M18×1.5	19
20	CFKR 47 VR	CFKR 47 V	CFKR 47 VUUR	CFKR 47 VUU	383	47	24	20	M20×1.5	21
	CFKR 52 VR	CFKR 52 V	CFKR 52 VUUR	CFKR 52 VUU	458	52	24	20	M20×1.5	21
24	CFKR 62 VR	CFKR 62 V	CFKR 62 VUUR	CFKR 62 VUU	800	62	29	24	M24×1.5	25
	CFKR 72 VR	CFKR 72 V	CFKR 72 VUUR	CFKR 72 VUU	1 120	72	29	24	M24×1.5	25
30	CFKR 80 VR	CFKR 80 V	CFKR 80 VUUR	CFKR 80 VUU	1 860	80	35	30	M30×1.5	32
	CFKR 85 VR	CFKR 85 V	CFKR 85 VUUR	CFKR 85 VUU	2 020	85				
	CFKR 90 VR	CFKR 90 V	CFKR 90 VUUR	CFKR 90 VUU	2 210	90				

Note⁽¹⁾ The identification number indicates the outer ring outside diameter.

⁽²⁾ Minimum allowable value of chamfer dimension r.

Remark Provided with prepacked grease.

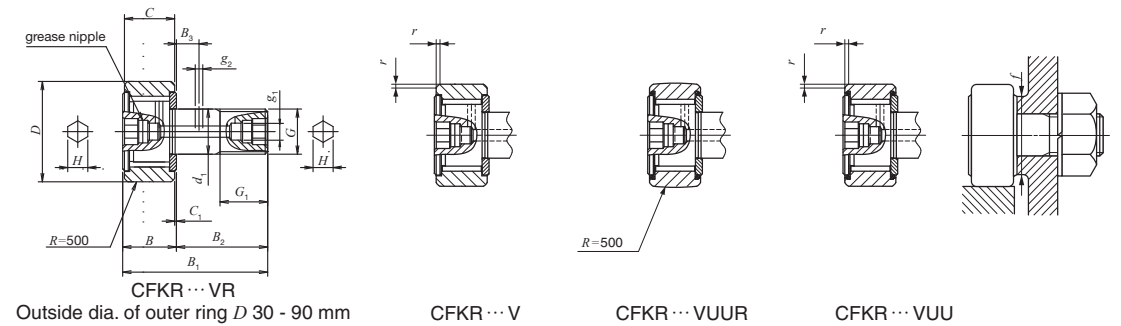

CFKR...VR
Outside dia. of outer ring D 30 - 90 mm

CFKR...V

CFKR...VUUR

CFKR...VUU

Boundary dimensions mm									Mounting dimension f Min. mm	Maximum tightening torque N·m	Basic dynamic load rating C N	Basic static load rating C ₀ N	Maximum allowable static load N
B _{max}	B _{1max}	B ₂	B ₃	C ₁	g ₁	g ₂	H	r _{s min} ⁽²⁾					
13.2	36.2	23	—	0.6	3	—	5	0.3	16	13.0	9 570	14 500	7 920
15.2	40.2	25	6	0.6	4	3	6	0.6	21	21.9	13 500	19 700	13 200
19.6	52.1	32.5	8	0.8	4	3	8	0.6	26	58.5	20 700	37 600	23 200
21.6	58.1	36.5	8	0.8	6	3	8	1	29	86.2	25 300	51 300	31 100
25.6	66.1	40.5	9	0.8	6	4	10	1	34	119	33 200	64 500	37 500
30.6	80.1	49.5	11	0.8	6	4	14	1	40	215	46 600	92 000	52 000
37	100	63	15	1	6	4	14	1	49	438	67 700	144 000	85 900

I

CF
CFKR
CFS
NUCF
CR

CAM FOLLOWERS

Eccentric Type Cam Followers CFE...B With Cage/Stud Head Hex Hole

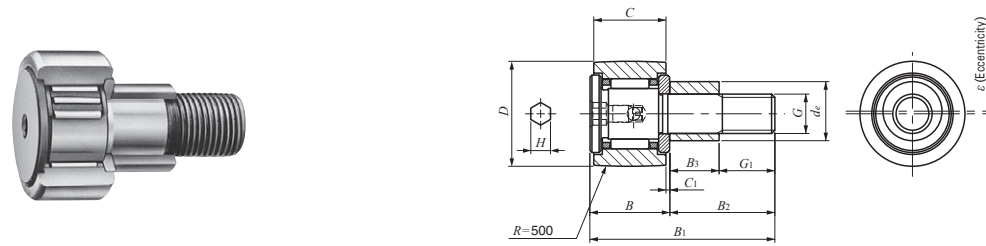

CFE...BR
Outside diameter of eccentric collar d_e 9-13mm

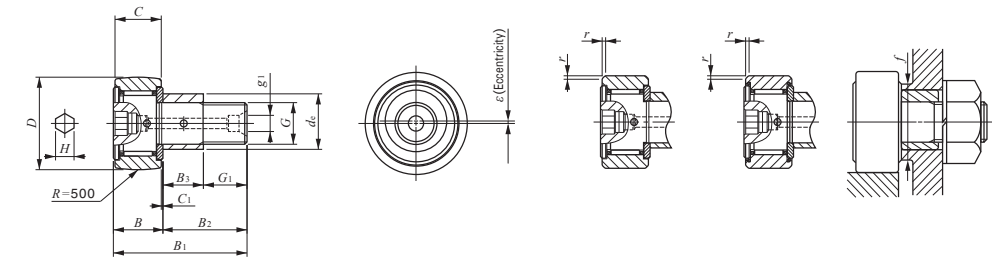

CFE...BR
Outside diameter of eccentric collar d_e 16-41mm
CFE...B CFE...BUU

Outside diameter of eccentric collar 9-41mm

Outside diameter of eccentric collar mm	Identification number				Mass (Ref.) g	D	C	d_e
	Shield type		Sealed type					
	With crowned outer ring	With cylindrical outer ring	With crowned outer ring	With cylindrical outer ring				
9	CFE 6 BR	CFE 6 B	CFE 6 BUUR	CFE 6 BUU	20.5	16	11	9
	CFE 10 BR	CFE 10 B	CFE 10 BUUR	CFE 10 BUU				
11	CFE 8 BR	CFE 8 B	CFE 8 BUUR	CFE 8 BUU	32	19	11	11
	CFE 10-1 BR	CFE 10-1 B	CFE 10-1 BUUR	CFE 10-1 BUU				
13	CFE 10 BR	CFE 10 B	CFE 10 BUUR	CFE 10 BUU	49.5	22	12	13
	CFE 10-1 BR	CFE 10-1 B	CFE 10-1 BUUR	CFE 10-1 BUU				
16	CFE 12 BR	CFE 12 B	CFE 12 BUUR	CFE 12 BUU	105	30	14	16
	CFE 12-1 BR	CFE 12-1 B	CFE 12-1 BUUR	CFE 12-1 BUU				
22	CFE 16 BR	CFE 16 B	CFE 16 BUUR	CFE 16 BUU	190	35	18	22
	CFE 18 BR	CFE 18 B	CFE 18 BUUR	CFE 18 BUU				
24	CFE 18 BR	CFE 18 B	CFE 18 BUUR	CFE 18 BUU	280	40	20	24
	CFE 20 BR	CFE 20 B	CFE 20 BUUR	CFE 20 BUU				
27	CFE 20 BR	CFE 20 B	CFE 20 BUUR	CFE 20 BUU	500	52	24	27
	CFE 20-1 BR	CFE 20-1 B	CFE 20-1 BUUR	CFE 20-1 BUU				
33	CFE 24 BR	CFE 24 B	CFE 24 BUUR	CFE 24 BUU	895	62	29	33
	CFE 24-1 BR	CFE 24-1 B	CFE 24-1 BUUR	CFE 24-1 BUU				
41	CFE 30 BR	CFE 30 B	CFE 30 BUUR	CFE 30 BUU	2 030	80	35	41
	CFE 30-1 BR	CFE 30-1 B	CFE 30-1 BUUR	CFE 30-1 BUU				
	CFE 30-2 BR	CFE 30-2 B	CFE 30-2 BUUR	CFE 30-2 BUU				

Note⁽¹⁾ Minimum allowable value of chamfer dimension r'
 Remarks1. Models with a thread diameter G of 10 mm or less have an oil hole (re-greasing fitting) at the head. Other models are provided with an oil hole (grease nipple) at the head and an oil hole on the end surface of the stud.
 2. Shield type models with a stud thread diameter G of 10 mm or less and the sealed type models are provided with prepacked grease. Other models are not provided with prepacked grease. Perform proper lubrication for use.

Boundary dimensions mm												Mounting dimension f Min. mm	Maximum tightening torque N-m	Basic dynamic load rating C N	Basic static load rating C_0 N	Maximum allowable static load N
G	B_3	B_{max}	B_{1max}	B_2	C_1	g_1	G_1	H	r'_{smin} ⁽¹⁾	Eccentricity ϵ						
M 6×1	7.5	12.2	28.2	16	0.6	—	8.5	3	0.3	0.4	11	2.7	3 660	3 650	1 950	
M 8×1.25	9.5	12.2	32.2	20	0.6	—	10.5	4	0.3	0.4	13	6.5	4 250	4 740	4 620	
M10×1.25	10.5	13.2	36.2	23	0.6	—	12.5	4	0.3	0.4	16	13.8	5 430	6 890	6 890	
M10×1.25	10.5	13.2	36.2	23	0.6	—	12.5	4	0.3	0.4	16	13.8	5 430	6 890	6 890	
M12×1.5	11.5	15.2	40.2	25	0.6	4	13.5	6	0.6	0.8	21	21.9	7 910	9 790	9 790	
M12×1.5	11.5	15.2	40.2	25	0.6	4	13.5	6	0.6	0.8	21	21.9	7 910	9 790	9 790	
M16×1.5	15.5	19.6	52.1	32.5	0.8	4	17	6	0.6	0.8	26	58.5	12 000	18 300	18 300	
M18×1.5	17.5	21.6	58.1	36.5	0.8	6	19	8	1	0.8	29	86.2	14 800	25 200	25 200	
M20×1.5	19.5	25.6	66.1	40.5	0.8	6	21	8	1	0.8	34	119	20 700	34 600	34 600	
M20×1.5	19.5	25.6	66.1	40.5	0.8	6	21	8	1	0.8	34	119	20 700	34 600	34 600	
M24×1.5	25.5	30.6	80.1	49.5	0.8	6	24	12	1	0.8	40	215	30 500	52 600	52 000	
M24×1.5	25.5	30.6	80.1	49.5	0.8	6	24	12	1	0.8	40	215	30 500	52 600	52 000	
M30×1.5	32.5	37	100	63	1	6	30.5	17	1	1.5	49	438	45 400	85 100	85 100	
M30×1.5	32.5	37	100	63	1	6	30.5	17	1	1.5	49	438	45 400	85 100	85 100	
M30×1.5	32.5	37	100	63	1	6	30.5	17	1	1.5	49	438	45 400	85 100	85 100	

I
CF
CFKR
CFS
NUCF
CR

CAM FOLLOWERS

Eccentric Type Cam Followers CFE...B Full Complement Type/Stud Head Hex Hole

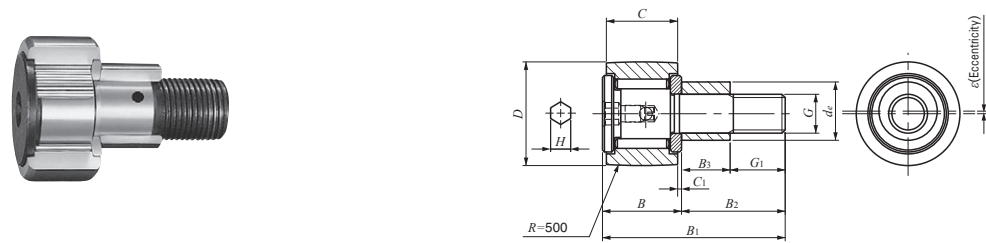

CFE...VBR
Outside diameter of eccentric collar d_e 9-13mm

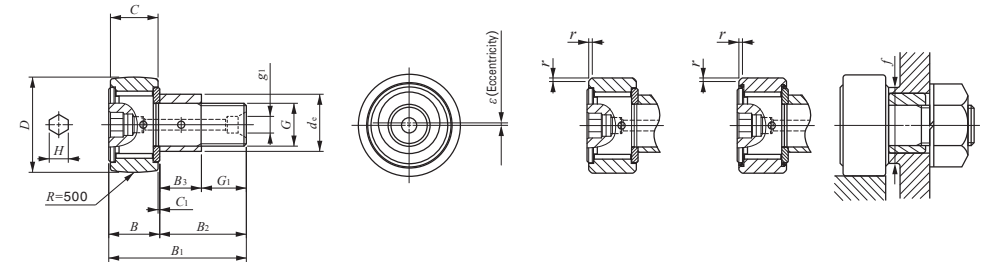

CFE...VBR CFE...VB CFE...VBUU
Outside diameter of eccentric collar d_e 16-41mm

Outside diameter of eccentric collar 9—41mm

Outside diameter of eccentric collar mm	Identification number				Mass (Ref.) g	D	C	d_e
	Shield type		Sealed type					
	With crowned outer ring	With cylindrical outer ring	With crowned outer ring	With cylindrical outer ring				
9	CFE 6 VBR	CFE 6 VB	CFE 6 VBUUR	CFE 6 VBUU	21	16	11	9
	CFE 6 VBR	CFE 6 VB	CFE 6 VBUUR	CFE 6 VBUU				
11	CFE 8 VBR	CFE 8 VB	CFE 8 VBUUR	CFE 8 VBUU	32.5	19	11	11
	CFE 8 VBR	CFE 8 VB	CFE 8 VBUUR	CFE 8 VBUU				
13	CFE 10 VBR	CFE 10 VB	CFE 10 VBUUR	CFE 10 VBUU	50.5	22	12	13
	CFE 10-1 VBR	CFE 10-1 VB	CFE 10-1 VBUUR	CFE 10-1 VBUU				
16	CFE 12 VBR	CFE 12 VB	CFE 12 VBUUR	CFE 12 VBUU	107	30	14	16
	CFE 12-1 VBR	CFE 12-1 VB	CFE 12-1 VBUUR	CFE 12-1 VBUU				
22	CFE 16 VBR	CFE 16 VB	CFE 16 VBUUR	CFE 16 VBUU	193	35	18	22
	CFE 16 VBR	CFE 16 VB	CFE 16 VBUUR	CFE 16 VBUU				
24	CFE 18 VBR	CFE 18 VB	CFE 18 VBUUR	CFE 18 VBUU	285	40	20	24
	CFE 18 VBR	CFE 18 VB	CFE 18 VBUUR	CFE 18 VBUU				
27	CFE 20 VBR	CFE 20 VB	CFE 20 VBUUR	CFE 20 VBUU	505	52	24	27
	CFE 20-1 VBR	CFE 20-1 VB	CFE 20-1 VBUUR	CFE 20-1 VBUU				
33	CFE 24 VBR	CFE 24 VB	CFE 24 VBUUR	CFE 24 VBUU	900	62	29	33
	CFE 24-1 VBR	CFE 24-1 VB	CFE 24-1 VBUUR	CFE 24-1 VBUU				
41	CFE 30 VBR	CFE 30 VB	CFE 30 VBUUR	CFE 30 VBUU	2 030	80	35	41
	CFE 30-1 VBR	CFE 30-1 VB	CFE 30-1 VBUUR	CFE 30-1 VBUU	2 190	85	35	41
	CFE 30-2 VBR	CFE 30-2 VB	CFE 30-2 VBUUR	CFE 30-2 VBUU	2 380	90	35	41

Note⁽¹⁾ Minimum allowable value of chamfer dimension r'
 Remarks1. Models with a thread diameter G of 10 mm or less have an oil hole (re-greasing fitting) at the head. Other models are provided with an oil hole (grease nipple) at the head and an oil hole on the end surface of the stud.
 2. Provided with prepacked grease.

Boundary dimensions mm												Mounting dimension f Min. mm	Maximum tightening torque N·m	Basic dynamic load rating C N	Basic static load rating C_0 N	Maximum allowable static load N
G	B_3	B_{max}	B_{1max}	B_2	C_1	g_1	G_1	H	r'_{smin} ⁽¹⁾	Eccentricity ϵ	Eccentricity ϵ					
M 6×1	7.5	12.2	28.2	16	0.6	—	8.5	3	0.3	0.4	11	2.7	6 980	8 500	1 950	
M 8×1.25	9.5	12.2	32.2	20	0.6	—	10.5	4	0.3	0.4	13	6.5	8 170	11 200	4 620	
M10×1.25	10.5	13.2	36.2	23	0.6	—	12.5	4	0.3	0.4	16	13.8	9 570	14 500	8 650	
M10×1.25	10.5	13.2	36.2	23	0.6	—	12.5	4	0.3	0.4	16	13.8	9 570	14 500	8 650	
M12×1.5	11.5	15.2	40.2	25	0.6	4	13.5	6	0.6	0.8	21	21.9	13 500	19 700	13 200	
M12×1.5	11.5	15.2	40.2	25	0.6	4	13.5	6	0.6	0.8	21	21.9	13 500	19 700	13 200	
M16×1.5	15.5	19.6	52.1	32.5	0.8	4	17	6	0.6	0.8	26	58.5	20 700	37 600	23 200	
M18×1.5	17.5	21.6	58.1	36.5	0.8	6	19	8	1	0.8	29	86.2	25 300	51 300	31 100	
M20×1.5	19.5	25.6	66.1	40.5	0.8	6	21	8	1	0.8	34	119	33 200	64 500	37 500	
M20×1.5	19.5	25.6	66.1	40.5	0.8	6	21	8	1	0.8	34	119	33 200	64 500	37 500	
M24×1.5	25.5	30.6	80.1	49.5	0.8	6	24	12	1	0.8	40	215	46 600	92 000	52 000	
M24×1.5	25.5	30.6	80.1	49.5	0.8	6	24	12	1	0.8	40	215	46 600	92 000	52 000	
M30×1.5	32.5	37	100	63	1	6	30.5	17	1	1.5	49	438	67 700	144 000	85 900	
M30×1.5	32.5	37	100	63	1	6	30.5	17	1	1.5	49	438	67 700	144 000	85 900	
M30×1.5	32.5	37	100	63	1	6	30.5	17	1	1.5	49	438	67 700	144 000	85 900	

I
CF
CFKR
CFS
NUCF
CR

CAM FOLLOWERS

Eccentric Type Cam Followers CFKRE Full complement/Double Hex Hole



CFKRE...VR
Outside diameter of eccentric collar d_e 13mm

Outside diameter of eccentric collar 13—35mm

Outside diameter of eccentric collar mm	Identification number ⁽¹⁾				Mass (Ref.) g	D	C	d_e
	Shield type		Sealed type					
	Crowned outer ring	Cylindrical outer ring	Crowned outer ring	Cylindrical outer ring				
13	CFKRE 22 VR	CFKRE 22 V	CFKRE 22 VUUR	CFKRE 22 VUU	48	22	12	13
	CFKRE 26 VR	CFKRE 26 V	CFKRE 26 VUUR	CFKRE 26 VUU	63	26	12	13
15	CFKRE 30 VR	CFKRE 30 V	CFKRE 30 VUUR	CFKRE 30 VUU	101	30	14	15
	CFKRE 32 VR	CFKRE 32 V	CFKRE 32 VUUR	CFKRE 32 VUU	111	32	14	15
20	CFKRE 35 VR	CFKRE 35 V	CFKRE 35 VUUR	CFKRE 35 VUU	180	35	18	20
22	CFKRE 40 VR	CFKRE 40 V	CFKRE 40 VUUR	CFKRE 40 VUU	269	40	20	22
24	CFKRE 47 VR	CFKRE 47 V	CFKRE 47 VUUR	CFKRE 47 VUU	402	47	24	24
	CFKRE 52 VR	CFKRE 52 V	CFKRE 52 VUUR	CFKRE 52 VUU	477	52	24	24
28	CFKRE 62 VR	CFKRE 62 V	CFKRE 62 VUUR	CFKRE 62 VUU	828	62	29	28
	CFKRE 72 VR	CFKRE 72 V	CFKRE 72 VUUR	CFKRE 72 VUU	1 150	72	29	28
35	CFKRE 80 VR	CFKRE 80 V	CFKRE 80 VUUR	CFKRE 80 VUU	1 920	80	35	35
	CFKRE 85 VR	CFKRE 85 V	CFKRE 85 VUUR	CFKRE 85 VUU	2 080	85	35	35
	CFKRE 90 VR	CFKRE 90 V	CFKRE 90 VUUR	CFKRE 90 VUU	2 270	90	35	35

Note⁽¹⁾ The identification number indicates the outer ring outside diameter.

⁽²⁾ Minimum allowable value of chamfer dimension r .

Remark Grease is prepacked.

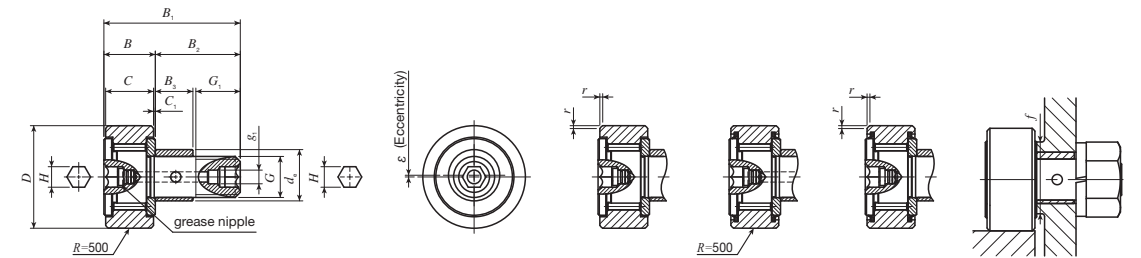

CFKRE...VR
Outside diameter of eccentric collar d_e 15~35mm

CFKRE...V CFKRE...VUU CFKRE...VUUR

G	Boundary dimensions mm										Eccentricity ϵ	Mounting dimension f Min. mm	Maximum tightening torque N-m	Basic dynamic load rating C N	Basic static load rating C_0 N	Maximum allowable static load N
	G_1	B_{max}	B_1_{max}	B_2	B_3	C_1	g_1	H	$r_{smin}^{(2)}$	ϵ						
M10×1.0	12	13.2	36.2	23	10	0.6	3	5	0.3	0.5	16	13.0	9 570	14 500	7 920	
M12×1.5	13	15.2	40.2	25	11	0.6	4	6	0.6	0.5	21	21.9	13 500	19 700	13 200	
M16×1.5	17	19.6	52.1	32.5	14	0.8	4	8	0.6	1	26	58.5	20 700	37 600	23 200	
M18×1.5	19	21.6	58.1	36.5	16	0.8	6	8	1	1	29	86.2	25 300	51 300	31 100	
M20×1.5	21	25.6	66.1	40.5	18	0.8	6	10	1	1	34	119	33 200	64 500	37 500	
M24×1.5	25	30.6	80.1	49.5	22	0.8	6	14	1	1	40	215	46 600	92 000	52 000	
M30×1.5	32	37	100	63	29	1	6	14	1	1.5	49	438	67 700	144 000	85 900	

I
CF
CFKR
CFS
NUCF
CR

CAM FOLLOWERS

Solid Eccentric Stud Type Cam Followers **With Cage/Stud Head Hex Hole**

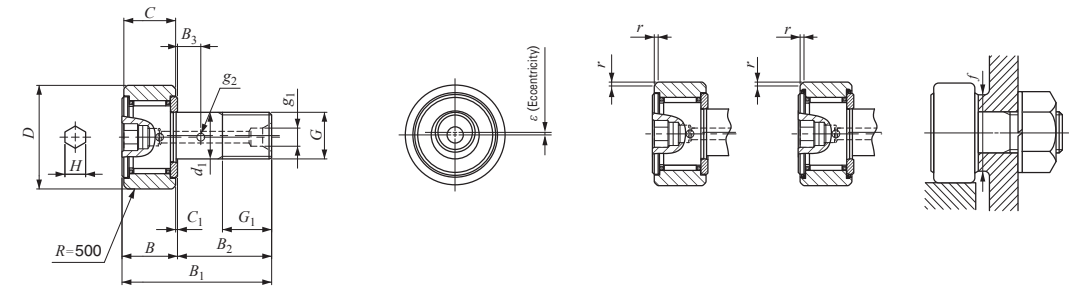
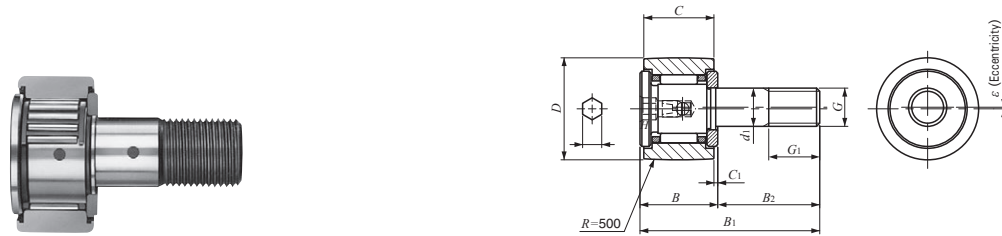

Stud dia. 6—18mm

CFES...BR
Stud dia. d_1 6-10mm

CFES...BR
Stud dia. d_1 12-18mm

CFES...B CFES...BUU

Stud dia. mm	Identification number					Mass (Ref.) g	D	C	d_1
	Shield type		Sealed type						
	With crowned outer ring	With cylindrical outer ring	With crowned outer ring	With cylindrical outer ring	With cylindrical outer ring				
6	CFES 6 BR	CFES 6 B	CFES 6 BUUR	CFES 6 BUU	18.5	16	11	6	
8	CFES 8 BR	CFES 8 B	CFES 8 BUUR	CFES 8 BUU	28.5	19	11	8	
10	CFES 10 BR	CFES 10 B	CFES 10 BUUR	CFES 10 BUU	45	22	12	10	
	CFES 10-1 BR	CFES 10-1 B	CFES 10-1 BUUR	CFES 10-1 BUU	60	26	12	10	
12	CFES 12 BR	CFES 12 B	CFES 12 BUUR	CFES 12 BUU	95	30	14	12	
	CFES 12-1 BR	CFES 12-1 B	CFES 12-1 BUUR	CFES 12-1 BUU	105	32	14	12	
16	CFES 16 BR	CFES 16 B	CFES 16 BUUR	CFES 16 BUU	170	35	18	16	
18	CFES 18 BR	CFES 18 B	CFES 18 BUUR	CFES 18 BUU	250	40	20	18	

Note⁽¹⁾ Minimum allowable value of chamfer dimension r
 Remarks1. Models with a stud diameter d_1 of 10 mm or less have an oil hole (re-greasing fitting) at the head. Other models are provided with an oil hole (grease nipple) at the head and an oil hole each on the outside surface and end surface of the stud.
 2. Shield type models with a stud diameter d_1 of 10 mm or less and the sealed type models are provided with prepacked grease. Other models are not provided with prepacked grease. Perform proper lubrication for use.

Boundary dimensions mm													Eccentricity ϵ	Mounting dimension f Min. mm	Maximum tightening torque N-m	Basic dynamic load rating C N	Basic static load rating C_0 N	Maximum allowable static load N
G	G_1	B_{max}	B_{1max}	B_2	B_3	C_1	g_1	g_2	H	$r_{smin}^{(1)}$	ϵ							
M 6×1	8	12.2	28.2	16	—	0.6	—	—	3	0.3	0.25	11	2.7	3 660	3 650	1 980		
M 8×1.25	10	12.2	32.2	20	—	0.6	—	—	4	0.3	0.25	13	6.5	4 250	4 740	4 670		
M10×1.25	12	13.2	36.2	23	—	0.6	—	—	4	0.3	0.3	16	13.8	5 430	6 890	6 890		
M10×1.25	12	13.2	36.2	23	—	0.6	—	—	4	0.3	0.3	16	13.8	5 430	6 890	6 890		
M12×1.5	13	15.2	40.2	25	6	0.6	4	3	6	0.6	0.4	21	21.9	7 910	9 790	9 790		
M12×1.5	13	15.2	40.2	25	6	0.6	4	3	6	0.6	0.4	21	21.9	7 910	9 790	9 790		
M16×1.5	17	19.6	52.1	32.5	8	0.8	4	3	6	0.6	0.5	26	58.5	12 000	18 300	18 300		
M18×1.5	19	21.6	58.1	36.5	8	0.8	6	3	8	1	0.6	29	86.2	14 800	25 200	25 200		

I
CF
CFKR
CFS
NUCF
CR

CAM FOLLOWERS

Thrust Disk Type Cam Followers With Cage/Stud Head Hex Hole

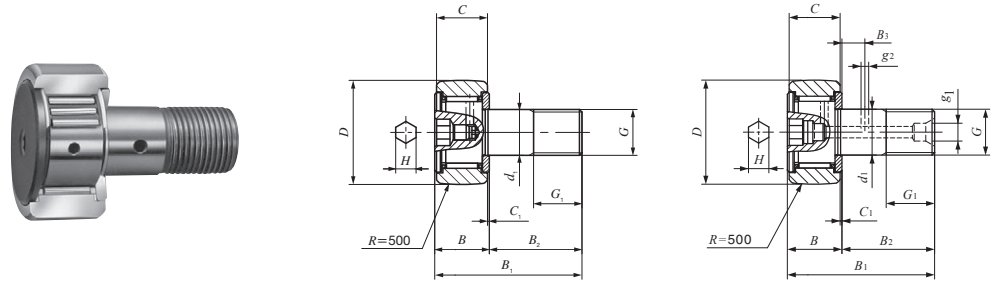

Stud dia. 3 – 20mm

CF...WBR
Stud dia. d_1 3-10mm

CF...WBR
Stud dia. d_1 12-20mm

Stud dia. mm	Identification number		Mass (Ref.) g	Boundary dimensions mm				
	Shield type	Sealed type		D	C	d_1	G	G_1
3	CF 3 WBR	CF 3 WBUUR	4.3	10	7	3	M 3 × 0.5	5
4	CF 4 WBR	CF 4 WBUUR	7.4	12	8	4	M 4 × 0.7	6
5	CF 5 WBR	CF 5 WBUUR	10.3	13	9	5	M 5 × 0.8	7.5
6	CF 6 WBR	CF 6 WBUUR	18.5	16	11	6	M 6 × 1	8
8	CF 8 WBR	CF 8 WBUUR	28.5	19	11	8	M 8 × 1.25	10
10	CF 10 WBR	CF 10 WBUUR	45	22	12	10	M10 × 1.25	12
	CF 10-1 WBR	CF 10-1 WBUUR	60	26	12	10	M10 × 1.25	12
12	CF 12 WBR	CF 12 WBUUR	95	30	14	12	M12 × 1.5	13
	CF 12-1 WBR	CF 12-1 WBUUR	105	32	14	12	M12 × 1.5	13
16	CF 16 WBR	CF 16 WBUUR	170	35	18	16	M16 × 1.5	17
18	CF 18 WBR	CF 18 WBUUR	250	40	20	18	M18 × 1.5	19
20	CF 20 WBR	CF 20 WBUUR	460	52	24	20	M20 × 1.5	21
	CF 20-1 WBR	CF 20-1 WBUUR	385	47	24	20	M20 × 1.5	21

Remarks1. Models with a stud diameter d_1 of 4 mm or less have no oil hole. For Models with a stud dia. 5 to 10 mm, oil hole (re-greasing fitting) is provided at the head. Other models are provided with an oil hole (grease nipple) at the head and an oil hole each on the outside surface and end surface of the stud.
2. Shield type models with a stud diameter d_1 of 10 mm or less and the sealed type models are provided with prepacked grease. Other models are not provided with prepacked grease. Perform proper lubrication for use.



CF...WBUUR

B	B ₁	B ₂	B ₃	C ₁	g ₁	g ₂	H	Mounting dimension f Min. mm	Maximum tightening torque N·m	Basic dynamic load rating C N	Basic static load rating C ₀ N	Maximum allowable static load N
8	17	9	—	0.5	—	—	2	6.8	0.34	1 500	1 020	384
9	20	11	—	0.5	—	—	2.5	8.3	0.78	2 070	1 590	834
10	23	13	—	0.5	—	—	3	9.3	1.6	2 520	2 140	1 260
12.2 max	28.2 max	16	—	0.6	—	—	3	11	2.7	3 660	3 650	1 950
12.2 max	32.2 max	20	—	0.6	—	—	4	13	6.5	4 250	4 740	4 620
13.2 max	36.2 max	23	—	0.6	—	—	4	16	13.8	5 430	6 890	6 890
13.2 max	36.2 max	23	—	0.6	—	—	4	16	13.8	5 430	6 890	6 890
15.2 max	40.2 max	25	6	0.6	4	3	6	21	21.9	7 910	9 790	9 790
15.2 max	40.2 max	25	6	0.6	4	3	6	21	21.9	7 910	9 790	9 790
19.6 max	52.1 max	32.5	8	0.8	4	3	6	26	58.5	12 000	18 300	18 300
21.6 max	58.1 max	36.5	8	0.8	6	3	8	29	86.2	14 800	25 200	25 200
25.6 max	66.1 max	40.5	9	0.8	6	4	8	34	119	20 700	34 600	34 600
25.6 max	66.1 max	40.5	9	0.8	6	4	8	34	119	20 700	34 600	34 600

I
CF
CFKR
CFS
NUCF
CR

CAM FOLLOWERS

Thrust Disk Type Cam Followers / Stainless Steel Made **With Cage/Stud Head Hex Hole**

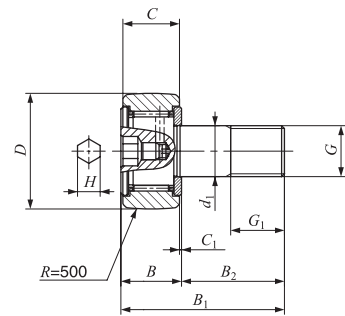
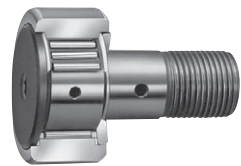

Stud dia. 3 – 5mm

CF...FWBR

Stud dia. mm	Identification number		Mass (Ref.) g	Boundary dimensions mm				
	Shield type	Sealed type		D	C	d ₁	G	G ₁
3	CF 3 FWBR	CF 3 FWBUUR	4.3	10	7	3	M 3 × 0.5	5
4	CF 4 FWBR	CF 4 FWBUUR	7.4	12	8	4	M 4 × 0.7	6
5	CF 5 FWBR	CF 5 FWBUUR	10.3	13	9	5	M 5 × 0.8	7.5

Remarks1. Models with a stud diameter d_1 of 4 mm or less have no oil hole. For Models with a stud dia. 5 mm, oil hole (re-greasing fitting) is provided at the head.
2. Provided with prepacked grease.



CF...FWBUUR

B	B ₁	B ₂	B ₃	C ₁	g ₁	g ₂	H	Mounting dimension f Min. mm	Maximum tightening torque N·m	Basic dynamic load rating C N	Basic static load rating C ₀ N	Maximum allowable static load N
9	20	11	—	0.5	—	—	2.5	8.3	0.78	1 650	1 270	834
10	23	13	—	0.5	—	—	3	9.3	1.6	1 930	1 730	1 260

I
CF
CFKR
CFS
NUCF
CR

CAM FOLLOWERS

Centralized Lubrication Type Cam Followers With Cage/Stud Head Hex Hole

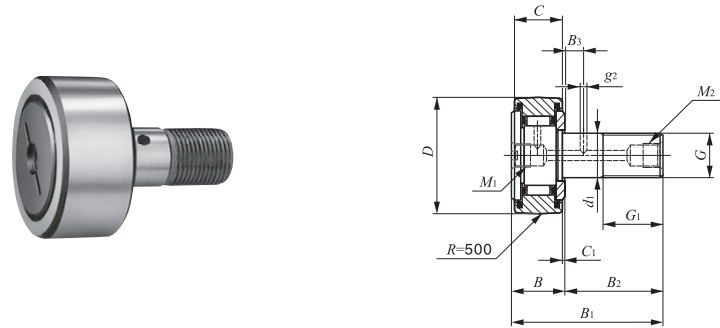

CF-RU1

Stud dia. 6 – 30mm

Stud dia. mm	Identification number		Mass (Ref.) g	Boundary dimensions mm				
	With crowned outer ring	With cylindrical outer ring		D	C	d ₁	G	G ₁
6	CF-RU1- 6	CF-FU1- 6	18.5	16	11	6	M 6 × 1	8
8	CF-RU1- 8	CF-FU1- 8	28.5	19	11	8	M 8 × 1.25	10
10	CF-RU1-10	CF-FU1-10	45	22	12	10	M10 × 1.25	12
	CF-RU1-10-1	CF-FU1-10-1	60	26	12	10	M10 × 1.25	12
12	CF-RU1-12	CF-FU1-12	95	30	14	12	M12 × 1.5	13
	CF-RU1-12-1	CF-FU1-12-1	105	32	14	12	M12 × 1.5	13
16	CF-RU1-16	CF-FU1-16	170	35	18	16	M16 × 1.5	17
18	CF-RU1-18	CF-FU1-18	250	40	20	18	M18 × 1.5	19
20	CF-RU1-20	CF-FU1-20	460	52	24	20	M20 × 1.5	21
	CF-RU1-20-1	CF-FU1-20-1	385	47	24	20	M20 × 1.5	21
24	CF-RU1-24	CF-FU1-24	815	62	29	24	M24 × 1.5	25
	CF-RU1-24-1	CF-FU1-24-1	1 140	72	29	24	M24 × 1.5	25
30	CF-RU1-30	CF-FU1-30	1 870	80	35	30	M30 × 1.5	32
	CF-RU1-30-1	CF-FU1-30-1	2 030	85	35	30	M30 × 1.5	32
	CF-RU1-30-2	CF-FU1-30-2	2 220	90	35	30	M30 × 1.5	32

Note⁽¹⁾ Minimum allowable value of chamfer dimension *r*
 Remarks1. Models with a stud diameter *d*₁ of 12 mm or less are provided with a lubrication tapped hole on the stud head only. Other models are provided with one lubrication tapped hole each on the head and end surface of the stud.
 2. Provided with prepacked grease.



CF-FU1

<i>B</i> _{max}	<i>B</i> _{1max}	<i>B</i> ₂	<i>B</i> ₃	<i>C</i> ₁	<i>g</i> ₂	<i>M</i> ₁	<i>M</i> ₂	<i>r</i> _{s min} ⁽¹⁾	Mounting dimension	Maximum tightening torque	Basic dynamic load rating	Basic static load rating	Maximum allowable static load
									<i>f</i> Min. mm	N-m	<i>C</i> N	<i>C</i> ₀ N	N
12.2	28.2	16	—	0.6	—	M6 × 0.75	—	0.3	11	2.7	3 660	3 650	1 950
12.2	32.2	20	—	0.6	—			0.3	13	6.5	4 250	4 740	4 620
13.2	36.2	23	—	0.6	—			0.3	16	13.8	5 430	6 890	6 890
13.2	36.2	23	—	0.6	—			0.3	16	13.8	5 430	6 890	6 890
15.2	40.2	25	—	0.6	—	PT 1/8	PT 1/8	0.6	21	23.9	7 910	9 790	9 790
15.2	40.2	25	—	0.6	—			0.6	21	23.9	7 910	9 790	9 790
19.6	52.1	32.5	8	0.8	3	PT 1/8	PT 1/8	0.6	26	58.5	12 000	18 300	18 300
21.6	58.1	36.5	8	0.8	3			1	29	86.2	14 800	25 200	25 200
25.6	66.1	40.5	9	0.8	4			1	34	119	20 700	34 600	34 600
25.6	66.1	40.5	9	0.8	4			1	34	119	20 700	34 600	34 600
30.6	80.1	49.5	11	0.8	4	PT 1/8	PT 1/8	1	40	215	30 500	52 600	52 000
30.6	80.1	49.5	11	0.8	4			1	40	215	30 500	52 600	52 000
37	100	63	15	1	4	PT 1/8	PT 1/8	1	49	438	45 400	85 100	85 100
37	100	63	15	1	4			1	49	438	45 400	85 100	85 100
37	100	63	15	1	4			1	49	438	45 400	85 100	85 100

I
CF
CFKR
CFS
NUCF
CR

CAM FOLLOWERS

Easy Mounting Type Cam Followers With Cage/Stud Head Hex Hole

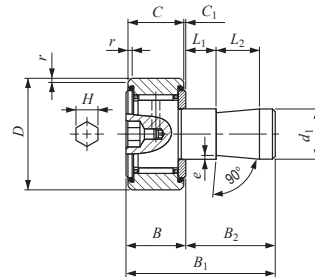
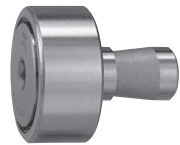

CF-SFU...B
Stud dia. d_1 6-10mm

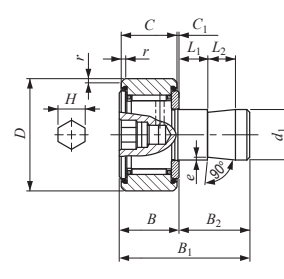

CF-SFU...B
Stud dia. d_1 12-20mm

Stud dia. 6 – 20mm

Stud dia. mm	Identification number	Mass (Ref.) g	Boundary dimensions mm							
			D	C	d_1	B_{max}	B_{1max}	B_2	C_1	L_1
6	CF-SFU- 6 B	19.5	16	11	6	12.2	32	19.8	0.6	5
8	CF-SFU- 8 B	29	19	11	8	12.2	32	19.8	0.6	5
10	CF-SFU-10 B	44	22	12	10	13.2	33	19.8	0.6	5
	CF-SFU-10-1 B	59	26	12	10	13.2	33	19.8	0.6	5
12	CF-SFU-12 B	94	30	14	12	15.2	35	19.8	0.6	5
	CF-SFU-12-1 B	104	32	14	12	15.2	35	19.8	0.6	5
16	CF-SFU-16 B	164	35	18	16	19.6	44.5	24.9	0.8	10
18	CF-SFU-18 B	235	40	20	18	21.6	46.5	24.9	0.8	10
20	CF-SFU-20 B	435	52	24	20	25.6	50.5	24.9	0.8	10
	CF-SFU-20-1 B	360	47	24	20	25.6	50.5	24.9	0.8	10

Note(1) Minimum allowable value of chamfer dimension r
 Remarks1. Models with a stud diameter d_1 of 10 mm or less have an oil hole (re-greasing fitting) at the head. Other models are provided with an oil hole (grease nipple) at the head.
 2. Provided with prepacked grease.

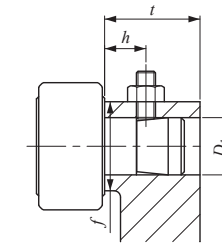

				Mounting dimensions mm					Basic dynamic load rating C	Basic static load rating C_0	Maximum allowable static load
L_2	H	e	$r_{s min}^{(1)}$	D_1	Tolerance	t Min.	f Min.	h (Ref.)	N	N	N
10	3	0.3	0.3	6	+0.012 0	20	11	10	3 660	3 650	1 950
10	4	0.5	0.3	8	+0.015 0	20	13	10	4 250	4 740	4 620
10	4	0.5	0.3	10		20	16	10	5 430	6 890	6 890
10	4	0.5	0.3	10		20	16	10	5 430	6 890	6 890
10	6	1	0.6	12	+0.018 0	20	21	10	7 910	9 790	9 790
10	6	1	0.6	12		20	21	10	7 910	9 790	9 790
10	6	1	0.6	16		25	26	15	12 000	18 300	18 300
10	8	1	1	18	+0.021 0	25	29	15	14 800	25 200	25 200
10	8	1	1	20		25	34	15	20 700	34 600	34 600
10	8	1	1	20		25	34	15	20 700	34 600	34 600

I
CF
CFKR
CFS
NUCF
CR

CAM FOLLOWERS

Cam Follower G With Cage/Stud Head Hex Hole

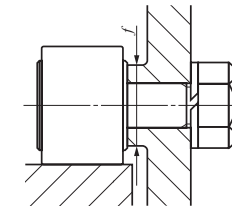
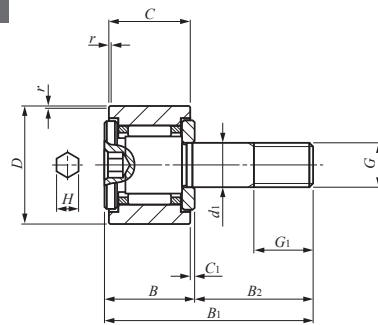
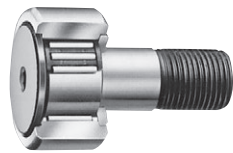

Stud dia. 6 – 20mm

CF...G

Stud dia. mm	Identification number	Mass (Ref.) g	Boundary dimensions mm						
			D	C	d ₁	G	G ₁	B _{max}	B _{1 max}
6	CF 6 G	19.5	16	11	6	M 6 × 1	8	12.2	28.2
8	CF 8 G	29.5	19	11	8	M 8 × 1.25	10	12.2	32.2
10	CF 10 G	47.5	22	12	10	M10 × 1.25	12	13.2	36.2
	CF 10-1 G	61.5	26	12	10	M10 × 1.25	12	13.2	36.2
12	CF 12 G	95.0	30	14	12	M12 × 1.5	13	15.2	40.2
	CF 12-1 G	105	32	14	12	M12 × 1.5	13	15.2	40.2
16	CF 16 G	175	35	18	16	M16 × 1.5	17	19.6	52.1
18	CF 18 G	255	40	20	18	M18 × 1.5	19	21.6	58.1
20	CF 20 G	470	52	24	20	M20 × 1.5	21	25.6	66.1
	CF 20-1 G	400	47	24	20	M20 × 1.5	21	25.6	66.1

Note⁽¹⁾ Minimum allowable value of chamfer dimension r.

Remarks1. This type of bearings cannot be re-lubricated due to the structure. If the environment requires re-lubrication, please use Standard Type Cam Followers.

2. Provided with prepacked grease.

B ₂	C ₁	H	r _{s min} ⁽¹⁾	Mounting dimension f Min. mm	Maximum tightening torque N-m	Basic dynamic load rating C N	Basic static load rating C ₀ N	Maximum allowable static load N
16	0.6	3	0.3	11	2.7	3 660	3 650	1 950
20	0.6	4	0.3	13	6.5	4 250	4 740	4 620
23	0.6	4	0.3	16	13.8	5 430	6 890	6 890
23	0.6	4	0.3	16	13.8	5 430	6 890	6 890
25	0.6	6	0.6	21	23.9	7 910	9 790	9 790
25	0.6	6	0.6	21	23.9	7 910	9 790	9 790
32.5	0.8	6	0.6	26	61.1	12 000	18 300	18 300
36.5	0.8	8	1	29	89.2	14 800	25 200	25 200
40.5	0.8	8	1	34	125	20 700	34 600	34 600
40.5	0.8	8	1	34	125	20 700	34 600	34 600

I
CF
CFKR
CFS
NUCF
CR

CAM FOLLOWERS

C-Lube Cam Followers **With Cage / Stud Head Hex Hole**

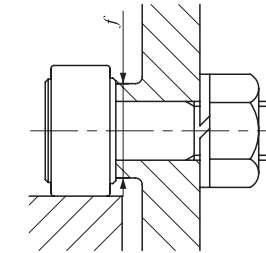
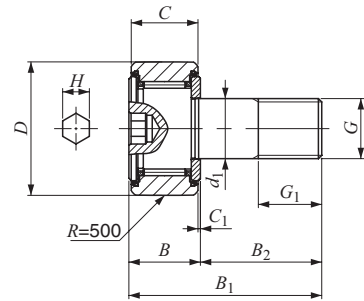
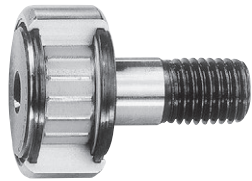

Stud dia. 5 – 20mm

CF...WB.../SG

Stud dia. mm	Identification number	Mass (Ref.) g	Boundary dimensions mm						
			D	C	d ₁	G	G ₁	B	B ₁
5	CF 5 WBUUR/SG	10.3	13	9	5	M 5 × 0.8	7.5	10	23
6	CF 6 WBUUR/SG	18.5	16	11	6	M 6 × 1	8	12.2 max	28.2 max
8	CF 8 WBUUR/SG	28.5	19	11	8	M 8 × 1.25	10	12.2 max	32.2 max
10	CF 10 WBUUR/SG	45	22	12	10	M10 × 1.25	12	13.2 max	36.2 max
	CF 10-1 WBUUR/SG	60	26	12	10	M10 × 1.25	12	13.2 max	36.2 max
12	CF 12 WBUUR/SG	95	30	14	12	M12 × 1.5	13	15.2 max	40.2 max
	CF 12-1 WBUUR/SG	105	32	14	12	M12 × 1.5	13	15.2 max	40.2 max
16	CF 16 WBUUR/SG	170	35	18	16	M16 × 1.5	17	19.6 max	52.1 max
18	CF 18 WBUUR/SG	250	40	20	18	M18 × 1.5	19	21.6 max	58.1 max
20	CF 20 WBUUR/SG	460	52	24	20	M20 × 1.5	21	25.6 max	66.1 max
	CF 20-1 WBUUR/SG	385	47	24	20	M20 × 1.5	21	25.6 max	66.1 max

Remark This bearing cannot be re-lubricated as thermosetting solid-type lubricant C-Lube fills its inner space.

B ₂	C ₁	H	Mounting dimension f Min. mm	Maximum tightening torque N-m	Basic dynamic load rating	Basic static load rating	Maximum allowable static load
					C	C ₀	
					N	N	N
13	0.5	3	9.3	1.6	2 520	2 140	1 260
16	0.6	3	11	2.7	3 660	3 650	1 950
20	0.6	4	13	6.5	4 250	4 740	4 620
23	0.6	4	16	13.8	5 430	6 890	6 890
23	0.6	4	16	13.8	5 430	6 890	6 890
25	0.6	6	21	21.9	7 910	9 790	9 790
25	0.6	6	21	21.9	7 910	9 790	9 790
32.5	0.8	6	26	58.5	12 000	18 300	18 300
36.5	0.8	8	29	86.2	14 800	25 200	25 200
40.5	0.8	8	34	119	20 700	34 600	34 600
40.5	0.8	8	34	119	20 700	34 600	34 600

I
CF
CFKR
CFS
NUCF
CR

CAM FOLLOWERS

Miniature Type Cam Followers **With Cage/Stud Head Hex Hole**
Full Complement Type/Stud Head Hex Hole

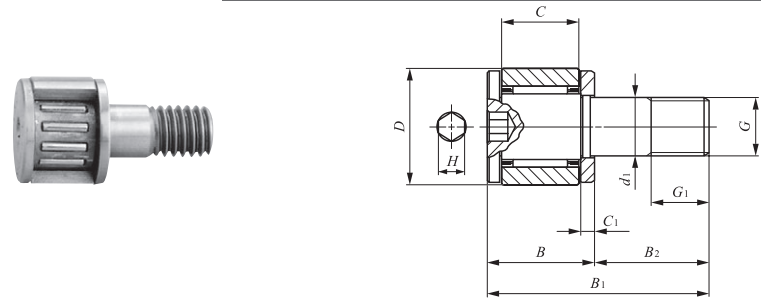

CFS

Stud dia. 2 – 6mm

Stud dia. mm	Identification number		Mass (Ref.) g	Boundary dimensions mm					
	With cage	Full complement		D	C	d ₁	G	G ₁	B
2	CFS 2	—	0.6	4.5	2.5	2	M2 × 0.4	2	4
	—	CFS 2 V	0.6	4.5	2.5	2	M2 × 0.4	2	4
2.5	CFS 2.5	—	1	5	3	2.5	M2.5 × 0.45	2.5	4.5
	—	CFS 2.5 V	1	5	3	2.5	M2.5 × 0.45	2.5	4.5
3	CFS 3	—	2	6	4	3	M3 × 0.5	3	5.5
	—	CFS 3 V	2	6	4	3	M3 × 0.5	3	5.5
4	CFS 4	—	4	8	5	4	M4 × 0.7	4	7
	—	CFS 4 V	4	8	5	4	M4 × 0.7	4	7
5	CFS 5	—	7	10	6	5	M5 × 0.8	5	8
	—	CFS 5 V	7	10	6	5	M5 × 0.8	5	8
6	CFS 6	—	13	12	7	6	M6 × 1	6	9.5
	—	CFS 6 V	13	12	7	6	M6 × 1	6	9.5

Remarks1. No oil hole is provided.
 2. Provided with prepacked grease.

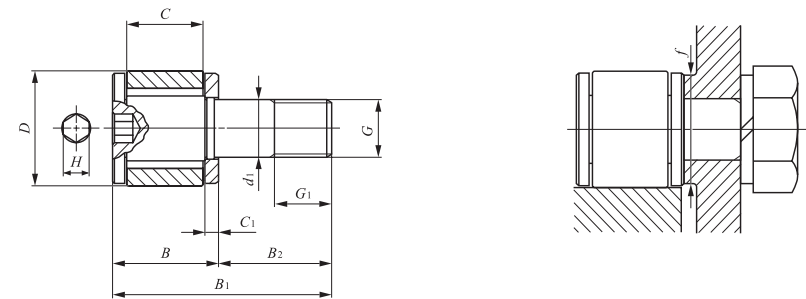

CFS...V

B ₁	B ₂	C ₁	H	Mounting dimension f Min. mm	Maximum tightening torque N·m	Basic dynamic load rating	Basic static load rating	Maximum allowable static load
						C N	C ₀ N	N
8	4	0.7	0.9	4.3	9.1	288	202	202
8	4	0.7	0.9	4.3	9.1	768	734	229
9.5	5	0.7	0.9	4.8	18.7	428	351	351
9.5	5	0.7	0.9	4.8	18.7	1 000	1 080	360
11.5	6	0.7	1.3	5.8	33.5	629	611	484
11.5	6	0.7	1.3	5.8	33.5	1 420	1 790	484
15	8	1.0	1.5	7.7	77.7	1 120	1 120	919
15	8	1.0	1.5	7.7	77.7	2 370	3 000	919
18	10	1.0	2	9.6	158	1 570	1 850	1 570
18	10	1.0	2	9.6	158	3 180	4 700	1 570
21.5	12	1.2	2.5	11.6	268	2 090	2 200	2 150
21.5	12	1.2	2.5	11.6	268	4 610	6 250	2 150

I
 CF
 CFKR
 CFS
 NUCF
 CR

CAM FOLLOWERS

Miniature Type Cam Followers / Stainless Steel Made **With Cage/Stud Head Hex Hole**
Full Complement Type/Stud Head Hex Hole

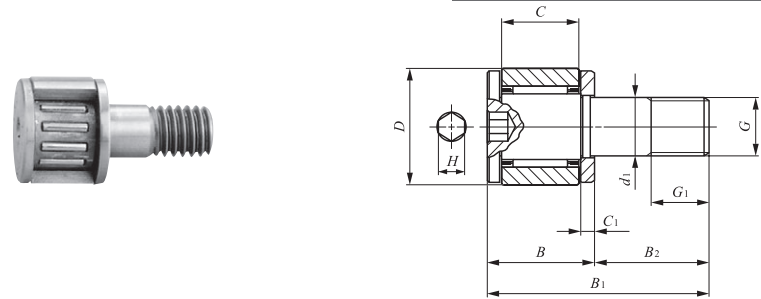

CFS...F

Stud dia. 2 – 6mm

Stud dia. mm	Identification number		Mass (Ref.) g	Boundary dimensions mm					
	With cage	Full complement		D	C	d ₁	G	G ₁	B
2	CFS 2 F	—	0.6	4.5	2.5	2	M2 × 0.4	2	4
	—	CFS 2 FV	0.6	4.5	2.5	2	M2 × 0.4	2	4
2.5	CFS 2.5 F	—	1	5	3	2.5	M2.5 × 0.45	2.5	4.5
	—	CFS 2.5 FV	1	5	3	2.5	M2.5 × 0.45	2.5	4.5
3	CFS 3 F	—	2	6	4	3	M3 × 0.5	3	5.5
	—	CFS 3 FV	2	6	4	3	M3 × 0.5	3	5.5
4	CFS 4 F	—	4	8	5	4	M4 × 0.7	4	7
	—	CFS 4 FV	4	8	5	4	M4 × 0.7	4	7
5	CFS 5 F	—	7	10	6	5	M5 × 0.8	5	8
	—	CFS 5 FV	7	10	6	5	M5 × 0.8	5	8
6	CFS 6 F	—	13	12	7	6	M6 × 1	6	9.5
	—	CFS 6 FV	13	12	7	6	M6 × 1	6	9.5

Remarks1. No oil hole is provided.
 2. Provided with prepacked grease.

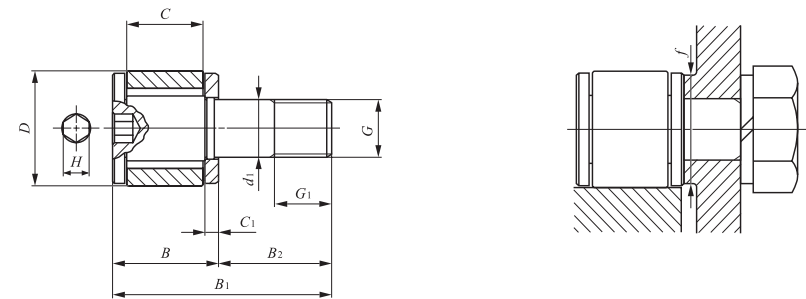

CFS...FV

B ₁	B ₂	C ₁	H	Mounting dimension f Min. mm	Maximum tightening torque N-cm	Basic dynamic load rating	Basic static load rating	Maximum allowable static load
						C	C ₀	N
8	4	0.7	0.9	4.3	9.1	230	161	161
8	4	0.7	0.9	4.3	9.1	614	587	229
9.5	5	0.7	0.9	4.8	18.7	342	281	281
9.5	5	0.7	0.9	4.8	18.7	800	862	360
11.5	6	0.7	1.3	5.8	33.5	504	488	484
11.5	6	0.7	1.3	5.8	33.5	1 140	1 430	484
15	8	1.0	1.5	7.7	77.7	897	894	894
15	8	1.0	1.5	7.7	77.7	1 900	2 400	919
18	10	1.0	2	9.6	158	1 250	1 480	1 480
18	10	1.0	2	9.6	158	2 540	3 760	1 570
21.5	12	1.2	2.5	11.6	268	1 670	1 760	1 760
21.5	12	1.2	2.5	11.6	268	3 690	5 000	2 150

I

CF
CFKR
CFS
NUCF
CR

CAM FOLLOWERS

Thrust Disk Type Miniature Cam Followers **With Cage/Stud Head Hex Hole**
Full Complement Type/Stud Head Hex Hole

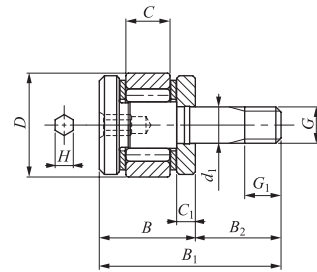
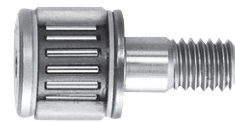

CFS1.4 WV

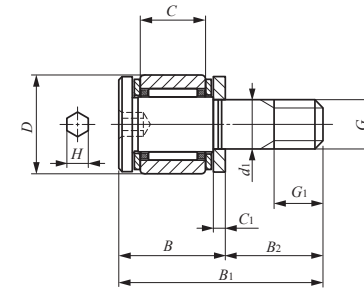

CFS... W

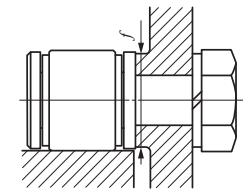

Stud dia. 1.4 – 6mm

Stud dia. mm	Identification number		Mass (Ref.) g	Boundary dimensions mm					
	With cage	Full complement		D	C	d ₁	G	G ₁	B
1.4	—	CFS 1.4 WV	0.35	4	1.7	1.4	M1.4 × 0.3	1.4	3.7
2	CFS 2 W	—	0.6	4.5	2.5	2	M2 × 0.4	2	4.5
2.5	CFS 2.5 W	—	1	5	3	2.5	M2.5 × 0.45	2.5	5
3	CFS 3 W	—	2	6	4	3	M3 × 0.5	3	6.5
4	CFS 4 W	—	4	8	5	4	M4 × 0.7	4	8
5	CFS 5 W	—	7	10	6	5	M5 × 0.8	5	9
6	CFS 6 W	—	13	12	7	6	M6 × 1	6	10.5

Remarks1. No oil hole is provided.
 2. Provided with prepacked grease.

B ₁	B ₂	C ₁	H	Mounting dimension f Min. mm	Maximum tightening torque N-cm	Basic dynamic load rating	Basic static load rating	Maximum allowable static load
						C	C ₀	
7	3.3	0.7	0.9	3.8	3.0	481	385	105
8.5	4	0.7	0.9	4.3	9.1	288	202	194
10	5	0.7	0.9	4.8	18.7	428	351	313
12.5	6	0.7	1.3	5.8	33.5	629	611	399
16	8	1	1.5	7.7	77.7	1120	1120	785
19	10	1	2	9.6	158	1570	1850	1370
22.5	12	1.2	2.5	11.6	268	2090	2200	1920

I
 CF
 CFKR
 CFS
 NUCF
 CR

CAM FOLLOWERS

Thrust Disk Type Miniature Cam Followers · Stainless Steel Made **With Cage/Stud Head Hex Hole**

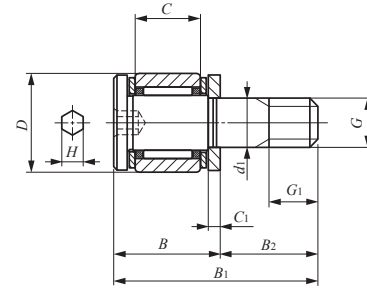
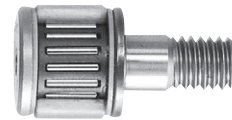

CFS...FW

Stud dia. 2 – 6mm

Stud dia. mm	Identification number	Mass (Ref.) g	Boundary dimensions mm					
			D	C	d ₁	G	G ₁	B
2	CFS 2 FW	0.6	4.5	2.5	2	M2 × 0.4	2	4.5
2.5	CFS 2.5 FW	1	5	3	2.5	M2.5 × 0.45	2.5	5
3	CFS 3 FW	2	6	4	3	M3 × 0.5	3	6.5
4	CFS 4 FW	4	8	5	4	M4 × 0.7	4	8
5	CFS 5 FW	7	10	6	5	M5 × 0.8	5	9
6	CFS 6 FW	13	12	7	6	M6 × 1	6	10.5

Remarks1. No oil hole is provided.
2. Provided with prepacked grease.

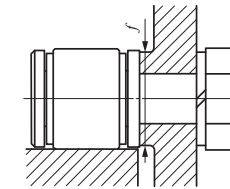

B ₁	B ₂	C ₁	H	Mounting dimension f Min. mm	Maximum tightening torque N-cm	Basic dynamic load rating C N	Basic static load rating C ₀ N	Maximum allowable static load N
8.5	4	0.7	0.9	4.3	9.1	230	161	161
10	5	0.7	0.9	4.8	18.7	342	281	281
12.5	6	0.7	1.3	5.8	33.5	504	488	399
16	8	1.0	1.5	7.7	77.7	897	894	785
19	10	1.0	2	9.6	158	1 250	1 480	1 370
22.5	12	1.2	2.5	11.6	268	1 670	1 760	1 760

I
CF
CFKR
CFS
NUCF
CR

CAM FOLLOWERS

Cylindrical Roller Cam Followers Full Complement Type/Stud Head Hex Hole

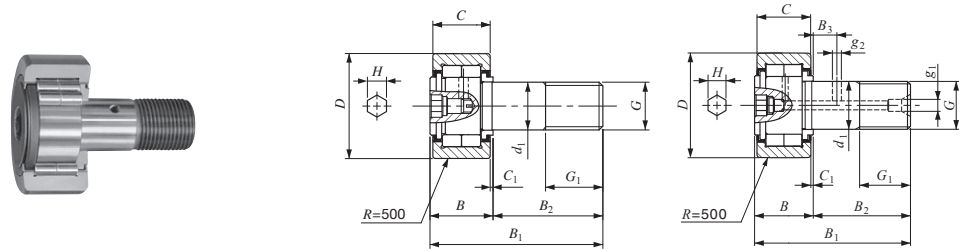

NUCF...BR
Stud dia. d_1 10mm

NUCF...BR
Stud dia. d_1 12-30mm

Stud dia. 10—30mm

Stud dia. mm	Identification number	Mass (Ref.) g	Boundary dimensions mm							
			D	C	d_1	G	G_1	B_{max}	B_{1max}	B_2
10	NUCF 10 BR	44	22	12	10	M10 × 1.25	12	13.2	36.2	23
	NUCF 10-1 BR	58	26	12	10	M10 × 1.25	12	13.2	36.2	23
12	NUCF 12 BR	86	30	14	12	M12 × 1.5	13	15.2	40.2	25
	NUCF 12-1 BR	97	32	14	12	M12 × 1.5	13	15.2	40.2	25
16	NUCF 16 BR	167	35	18	16	M16 × 1.5	17	19.6	52.1	32.5
18	NUCF 18 BR	244	40	20	18	M18 × 1.5	19	21.6	58.1	36.5
20	NUCF 20 BR	457	52	24	20	M20 × 1.5	21	25.6	66.1	40.5
	NUCF 20-1 BR	384	47	24	20	M20 × 1.5	21	25.6	66.1	40.5
24	NUCF 24 BR	789	62	29	24	M24 × 1.5	25	30.6	80.1	49.5
	NUCF 24-1 BR	1 020	72	29	24	M24 × 1.5	25	30.6	80.1	49.5
30	NUCF 30 BR	1 600	80	35	30	M30 × 1.5	32	37	100	63
	NUCF 30-2 BR	1 970	90	35	30	M30 × 1.5	32	37	100	63

Remarks1. For models with a stud diameter d_1 of 10mm, oil hole (re-greasing fitting) is provided at the head. Other models are provided with an oil hole (grease nipple) at the head and an oil hole each on the outside surface and end surface of the stud.
2. Provided with prepacked grease.

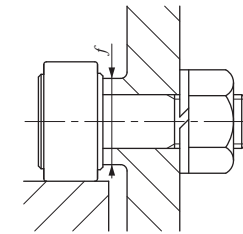

B_3	C_1	g_1	g_2	H	Mounting dimension f Min. mm	Maximum tightening torque N·m	Basic dynamic	Basic static	Maximum allowable static load N
							load rating C N	load rating C_0 N	
—	0.6	—	—	4	12	13.8	10 400	11 500	5 300
—	0.6	—	—	4	12	13.8	10 400	11 500	9 210
6	0.6	4	3	6	17	21.9	14 000	13 400	5 650
6	0.6	4	3	6	17	21.9	14 000	13 400	9 040
8	0.8	4	3	6	20	58.5	23 400	27 300	11 800
8	0.8	6	3	8	22	86.2	25 200	30 900	20 300
9	0.8	6	4	8	31	119	43 100	58 100	30 000
9	0.8	6	4	8	27	119	38 900	49 000	27 200
11	0.8	6	4	12	38	215	58 200	75 300	35 200
11	0.8	6	4	12	44	215	63 900	88 800	57 000
15	1	6	4	17	45	438	90 300	121 000	98 300
15	1	6	4	17	45	438	90 300	121 000	98 300

I
CF
CFKR
CFS
NUCF
CR

CAM FOLLOWERS

Inch Series Cam Followers With Cage/Stud Head Hex Hole

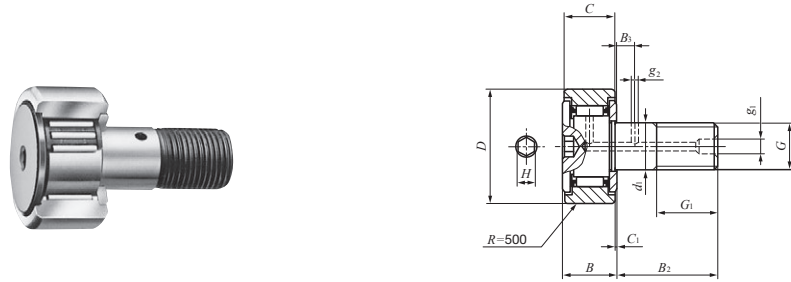

Stud dia. 4.826 – 22.225mm

CR...BR

Stud dia. mm (inch)	Identification number				Mass (Ref.) g	D	C	d ₁	G UNF	G ₁
	Shield type		Sealed type							
	With crowned outer ring	With cylindrical outer ring	With crowned outer ring	With cylindrical outer ring						
4.826	CR 8 BR	CR 8 B	CR 8 BUUR	CR 8 BUU	9	12.700 (1/2)	8.731 (11/32)	4.826	No.10-32	6.350 (1/4)
	CR 8-1 BR	CR 8-1 B	CR 8-1 BUUR	CR 8-1 BUU	10	12.700 (1/2)	9.525 (3/8)	4.826	No.10-32	6.350 (1/4)
6.350 (1/4)	CR 10 BR	CR 10 B	CR 10 BUUR	CR 10 BUU	19	15.875 (5/8)	10.319 (13/32)	6.350 (1/4)	1/4-28	7.938 (5/16)
	CR 10-1 BR	CR 10-1 B	CR 10-1 BUUR	CR 10-1 BUU	21	15.875 (5/8)	11.112 (7/16)	6.350 (1/4)	1/4-28	7.938 (5/16)
9.525 (3/8)	CR 12 BR	CR 12 B	CR 12 BUUR	CR 12 BUU	35	19.050 (3/4)	12.700 (1/2)	9.525 (3/8)	3/8-24	9.525 (3/8)
	CR 14 BR	CR 14 B	CR 14 BUUR	CR 14 BUU	46	22.225 (7/8)	12.700 (1/2)	9.525 (3/8)	3/8-24	9.525 (3/8)
11.112 (7/16)	CR 16 BR	CR 16 B	CR 16 BUUR	CR 16 BUU	73	25.400 (1)	15.875 (5/8)	11.112 (7/16)	7/16-20	12.700 (1/2)
	CR 18 BR	CR 18 B	CR 18 BUUR	CR 18 BUU	99	28.575 (1 1/8)	15.875 (5/8)	11.112 (7/16)	7/16-20	12.700 (1/2)
12.700 (1/2)	CR 20 BR	CR 20 B	CR 20 BUUR	CR 20 BUU	132	31.750 (1 1/4)	19.050 (3/4)	12.700 (1/2)	1/2-20	15.875 (5/8)
	CR 22 BR	CR 22 B	CR 22 BUUR	CR 22 BUU	157	34.925 (1 3/8)	19.050 (3/4)	12.700 (1/2)	1/2-20	15.875 (5/8)
15.875 (5/8)	CR 24 BR	CR 24 B	CR 24 BUUR	CR 24 BUU	225	38.100 (1 1/2)	22.225 (7/8)	15.875 (5/8)	5/8-18	19.050 (3/4)
	CR 26 BR	CR 26 B	CR 26 BUUR	CR 26 BUU	260	41.275 (1 5/8)	22.225 (7/8)	15.875 (5/8)	5/8-18	19.050 (3/4)
19.050 (3/4)	CR 28 BR	CR 28 B	CR 28 BUUR	CR 28 BUU	365	44.450 (1 3/4)	25.400 (1)	19.050 (3/4)	3/4-16	22.225 (7/8)
	CR 30 BR	CR 30 B	CR 30 BUUR	CR 30 BUU	410	47.625 (1 7/8)	25.400 (1)	19.050 (3/4)	3/4-16	22.225 (7/8)
22.225 (7/8)	CR 32 BR	CR 32 B	CR 32 BUUR	CR 32 BUU	615	50.800 (2)	31.750 (1 1/4)	22.225 (7/8)	7/8-14	25.400 (1)
	CR 36 BR	CR 36 B	CR 36 BUUR	CR 36 BUU	750	57.150 (2 1/4)	31.750 (1 1/4)	22.225 (7/8)	7/8-14	25.400 (1)

Remarks1. Models with a stud diameter d₁ of 6.35 mm or less have no oil hole. Other models are provided with one oil hole each on the outside surface and end surface of the stud.
 2. Provided with prepacked grease.
 3. For the maximum allowable static load, please contact IKO.

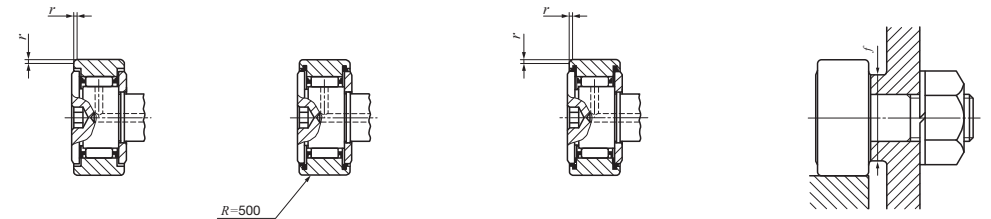

CR...B

CR...BUUR

CR...BUU

Boundary dimensions mm(inch)								Mounting dimension f Min. mm(inch)	Maximum tightening torque N·m	Basic dynamic load rating C N	Basic static load rating C ₀ N
B max	B ₂	B ₃	C ₁	g ₁	g ₂	H	r				
10.2 (0.40)	12.700 (1/2)	— (—)	0.794 (1/32)	— (—)	— (—)	3.175 (1/8)	0.397 (1/64)	8.334 (21/64)	1.4	2 520	2 140
10.9 (0.43)	15.875 (5/8)	— (—)	0.794 (1/32)	— (—)	— (—)	3.175 (1/8)	0.397 (1/64)	8.334 (21/64)	1.4	2 520	2 140
11.8 (0.46)	15.875 (5/8)	— (—)	0.794 (1/32)	— (—)	— (—)	3.175 (1/8)	0.397 (1/64)	11.509 (29/64)	3.4	3 650	3 670
12.5 (0.49)	19.050 (3/4)	— (—)	0.794 (1/32)	— (—)	— (—)	3.175 (1/8)	0.397 (1/64)	11.509 (29/64)	3.4	3 650	3 670
14.2 (0.56)	22.225 (7/8)	6.350 (1/4)	0.794 (1/32)	4.762 (3/16)	2.381 (3/32)	4.762 (3/16)	0.794 (1/32)	13.494 (17/32)	10.8	4 420	5 110
14.2 (0.56)	22.225 (7/8)	6.350 (1/4)	0.794 (1/32)	4.762 (3/16)	2.381 (3/32)	4.762 (3/16)	0.794 (1/32)	15.081 (19/32)	10.8	4 790	5 810
17.3 (0.68)	25.400 (1)	6.350 (1/4)	0.794 (1/32)	4.762 (3/16)	3.175 (1/8)	6.350 (1/4)	1.191 (3/64)	17.859 (45/64)	17.4	8 810	10 800
17.3 (0.68)	25.400 (1)	6.350 (1/4)	0.794 (1/32)	4.762 (3/16)	3.175 (1/8)	6.350 (1/4)	1.588 (1/16)	19.050 (3/4)	17.4	9 180	11 600
20.4 (0.80)	31.750 (1 1/4)	7.938 (5/16)	0.794 (1/32)	4.762 (3/16)	3.175 (1/8)	6.350 (1/4)	1.588 (1/16)	21.828 (55/64)	27.7	14 200	16 000
20.4 (0.80)	31.750 (1 1/4)	7.938 (5/16)	0.794 (1/32)	4.762 (3/16)	3.175 (1/8)	6.350 (1/4)	1.588 (1/16)	21.828 (55/64)	27.7	14 200	16 000
23.6 (0.93)	38.100 (1 1/2)	9.525 (3/8)	0.794 (1/32)	4.762 (3/16)	3.969 (5/32)	7.938 (5/16)	1.588 (1/16)	26.196 (13/64)	55.7	18 600	24 300
23.6 (0.93)	38.100 (1 1/2)	9.525 (3/8)	0.794 (1/32)	4.762 (3/16)	3.969 (5/32)	7.938 (5/16)	1.588 (1/16)	26.196 (13/64)	55.7	18 600	24 300
26.8 (1.06)	44.450 (1 3/4)	11.112 (7/16)	0.794 (1/32)	4.762 (3/16)	3.969 (5/32)	7.938 (5/16)	1.588 (1/16)	32.543 (19/32)	100	25 100	38 200
26.8 (1.06)	44.450 (1 3/4)	11.112 (7/16)	0.794 (1/32)	4.762 (3/16)	3.969 (5/32)	7.938 (5/16)	1.588 (1/16)	32.543 (19/32)	100	25 100	38 200
33.5 (1.32)	50.800 (2)	12.700 (1/2)	0.794 (1/32)	4.762 (3/16)	4.762 (3/16)	11.112 (7/16)	1.588 (1/16)	37.306 (115/32)	162	32 500	63 900
33.5 (1.32)	50.800 (2)	12.700 (1/2)	0.794 (1/32)	4.762 (3/16)	4.762 (3/16)	11.112 (7/16)	1.588 (1/16)	37.306 (115/32)	162	32 500	63 900

I
CF
CFKR
CFS
NUCF
CR

CAM FOLLOWERS

Inch Series Cam Followers With Cage/With Screwdriver Slot

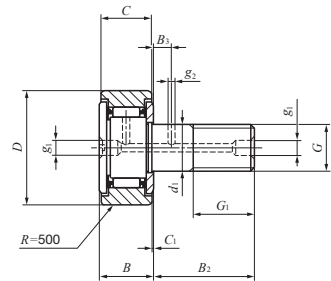
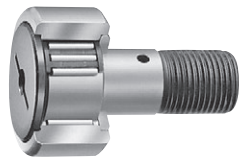

CR...R

Stud dia. 4.826 – 22.225mm

Stud dia. mm (inch)	Identification number				Mass (Ref.) g	D	C	d ₁	G UNF	G ₁
	Shield type		Sealed type							
	With crowned outer ring	With cylindrical outer ring	With crowned outer ring	With cylindrical outer ring						
4.826	CR 8 R	CR 8	CR 8 UUR	CR 8 UU	9	12.700 (1/2)	8.731 (11/32)	4.826	No.10-32	6.350 (1/4)
	CR 8-1 R	CR 8-1	CR 8-1 UUR	CR 8-1 UU	10	12.700 (1/2)	9.525 (3/8)	4.826	No.10-32	6.350 (1/4)
6.350 (1/4)	CR 10 R	CR 10	CR 10 UUR	CR 10 UU	19	15.875 (5/8)	10.319 (13/32)	6.350 (1/4)	1/4-28	7.938 (5/16)
	CR 10-1 R	CR 10-1	CR 10-1 UUR	CR 10-1 UU	21	15.875 (5/8)	11.112 (7/16)	6.350 (1/4)	1/4-28	7.938 (5/16)
9.525 (3/8)	CR 12 R	CR 12	CR 12 UUR	CR 12 UU	35	19.050 (3/4)	12.700 (1/2)	9.525 (3/8)	3/8-24	9.525 (3/8)
	CR 14 R	CR 14	CR 14 UUR	CR 14 UU	46	22.225 (7/8)	12.700 (1/2)	9.525 (3/8)	3/8-24	9.525 (3/8)
11.112 (7/16)	CR 16 R	CR 16	CR 16 UUR	CR 16 UU	73	25.400 (1)	15.875 (5/8)	11.112 (7/16)	7/16-20	12.700 (1/2)
	CR 18 R	CR 18	CR 18 UUR	CR 18 UU	99	28.575 (1 1/8)	15.875 (5/8)	11.112 (7/16)	7/16-20	12.700 (1/2)
12.700 (1/2)	CR 20 R	CR 20	CR 20 UUR	CR 20 UU	132	31.750 (1 1/4)	19.050 (3/4)	12.700 (1/2)	1/2-20	15.875 (5/8)
	CR 22 R	CR 22	CR 22 UUR	CR 22 UU	157	34.925 (1 3/8)	19.050 (3/4)	12.700 (1/2)	1/2-20	15.875 (5/8)
15.875 (5/8)	CR 24 R	CR 24	CR 24 UUR	CR 24 UU	225	38.100 (1 1/2)	22.225 (7/8)	15.875 (5/8)	5/8-18	19.050 (3/4)
	CR 26 R	CR 26	CR 26 UUR	CR 26 UU	260	41.275 (1 5/8)	22.225 (7/8)	15.875 (5/8)	5/8-18	19.050 (3/4)
19.050 (3/4)	CR 28 R	CR 28	CR 28 UUR	CR 28 UU	365	44.450 (1 3/4)	25.400 (1)	19.050 (3/4)	3/4-16	22.225 (7/8)
	CR 30 R	CR 30	CR 30 UUR	CR 30 UU	410	47.625 (1 7/8)	25.400 (1)	19.050 (3/4)	3/4-16	22.225 (7/8)
22.225 (7/8)	CR 32 R	CR 32	CR 32 UUR	CR 32 UU	615	50.800 (2)	31.750 (1 1/4)	22.225 (7/8)	7/8-14	25.400 (1)
	CR 36 R	CR 36	CR 36 UUR	CR 36 UU	750	57.150 (2 1/4)	31.750 (1 1/4)	22.225 (7/8)	7/8-14	25.400 (1)

Remarks1. Models with a stud diameter d_1 of 6.35 mm or less (marked *) are provided with an oil hole on the stud head only. Other models are provided with one oil hole each on the head, outside surface and end surface of the stud.
 2. Provided with prepacked grease.
 3. For the maximum allowable static load, please contact IKO.

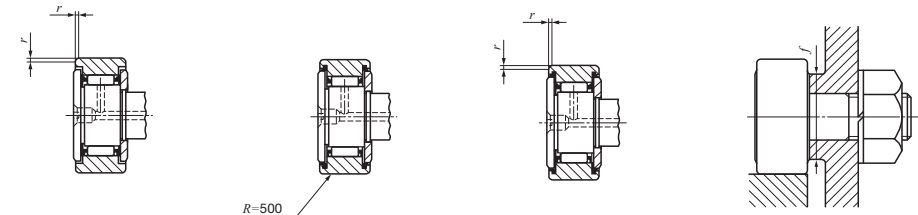

CR

CR...UUR

CR...UU

Boundary dimensions mm(inch)							Mounting dimension f Min. mm(inch)	Maximum tightening torque N-m	Basic dynamic load rating C N	Basic static load rating C ₀ N
B max	B ₂	B ₃	C ₁	g ₁	g ₂	r				
10.2 (0.40)	12.700 (1/2)	— (—)	0.794 (1/32)	*3.175 (1/8)	— (—)	0.397 (1/64)	8.334 (21/64)	1.4	2 520	2 140
10.9 (0.43)	15.875 (5/8)	— (—)	0.794 (1/32)	*3.175 (1/8)	— (—)	0.397 (1/64)	8.334 (21/64)	1.4	2 520	2 140
11.8 (0.46)	15.875 (5/8)	— (—)	0.794 (1/32)	*3.175 (1/8)	— (—)	0.397 (1/64)	11.509 (29/64)	3.4	3 650	3 670
12.5 (0.49)	19.050 (3/4)	— (—)	0.794 (1/32)	*3.175 (1/8)	— (—)	0.397 (1/64)	11.509 (29/64)	3.4	3 650	3 670
14.2 (0.56)	22.225 (7/8)	6.350 (1/4)	0.794 (1/32)	4.762 (3/16)	2.381 (3/32)	0.794 (1/32)	13.494 (17/32)	10.8	4 420	5 110
14.2 (0.56)	22.225 (7/8)	6.350 (1/4)	0.794 (1/32)	4.762 (3/16)	2.381 (3/32)	0.794 (1/32)	15.081 (19/32)	10.8	4 790	5 810
17.3 (0.68)	25.400 (1)	6.350 (1/4)	0.794 (1/32)	4.762 (3/16)	3.175 (1/8)	1.191 (3/64)	17.859 (45/64)	17.4	8 810	10 800
17.3 (0.68)	25.400 (1)	6.350 (1/4)	0.794 (1/32)	4.762 (3/16)	3.175 (1/8)	1.588 (1/16)	19.050 (3/4)	17.4	9 180	11 600
20.4 (0.80)	31.750 (1 1/4)	7.938 (5/16)	0.794 (1/32)	4.762 (3/16)	3.175 (1/8)	1.588 (1/16)	21.828 (55/64)	27.7	14 200	16 000
20.4 (0.80)	31.750 (1 1/4)	7.938 (5/16)	0.794 (1/32)	4.762 (3/16)	3.175 (1/8)	1.588 (1/16)	21.828 (55/64)	27.7	14 200	16 000
23.6 (0.93)	38.100 (1 1/2)	9.525 (3/8)	0.794 (1/32)	4.762 (3/16)	3.969 (5/32)	1.588 (1/16)	26.196 (1 3/64)	55.7	18 600	24 300
23.6 (0.93)	38.100 (1 1/2)	9.525 (3/8)	0.794 (1/32)	4.762 (3/16)	3.969 (5/32)	1.588 (1/16)	26.196 (1 3/64)	55.7	18 600	24 300
26.8 (1.06)	44.450 (1 3/4)	11.112 (7/16)	0.794 (1/32)	4.762 (3/16)	3.969 (5/32)	1.588 (1/16)	32.543 (1 9/32)	100	25 100	38 200
26.8 (1.06)	44.450 (1 3/4)	11.112 (7/16)	0.794 (1/32)	4.762 (3/16)	3.969 (5/32)	1.588 (1/16)	32.543 (1 9/32)	100	25 100	38 200
33.5 (1.32)	50.800 (2)	12.700 (1/2)	0.794 (1/32)	4.762 (3/16)	4.762 (3/16)	1.588 (1/16)	37.306 (1 15/32)	162	32 500	63 900
33.5 (1.32)	50.800 (2)	12.700 (1/2)	0.794 (1/32)	4.762 (3/16)	4.762 (3/16)	1.588 (1/16)	37.306 (1 15/32)	162	32 500	63 900

I
CF
CFKR
CFS
NUCF
CR

CAM FOLLOWERS

Inch Series Cam Followers Full Complement Type/Stud Head Hex Hole

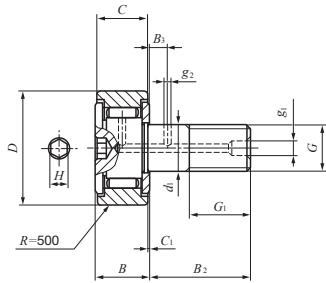
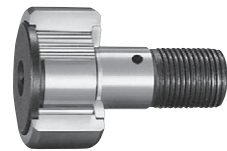

CR...VBR

Stud dia. 4.826 – 22.225mm

Stud dia. mm (inch)	Identification number				Mass (Ref.) g	Boundary dimensions mm (inch)				
	Shield type With crowned outer ring		Sealed type With crowned outer ring			D	C	d ₁	G UNF	G ₁
4.826	CR 8 VBR	CR 8 VB	CR 8 VBUUR	CR 8 VBUU	9	12.700 (1/2)	8.731 (11/32)	4.826	No.10-32	6.350 (1/4)
	CR 8-1 VBR	CR 8-1VB	CR 8-1 VBUUR	CR 8-1 VBUU	10	12.700 (1/2)	9.525 (3/8)	4.826	No.10-32	6.350 (1/4)
6.350 (1/4)	CR 10 VBR	CR 10 VB	CR 10 VBUUR	CR 10 VBUU	19	15.875 (5/8)	10.319 (13/32)	6.350 (1/4)	1/4-28	7.938 (5/16)
	CR 10-1 VBR	CR 10-1VB	CR 10-1 VBUUR	CR 10-1 VBUU	21	15.875 (5/8)	11.112 (7/16)	6.350 (1/4)	1/4-28	7.938 (5/16)
9.525 (3/8)	CR 12 VBR	CR 12 VB	CR 12 VBUUR	CR 12 VBUU	36	19.050 (3/4)	12.700 (1/2)	9.525 (3/8)	3/8-24	9.525 (3/8)
	CR 14 VBR	CR 14 VB	CR 14 VBUUR	CR 14 VBUU	47	22.225 (7/8)	12.700 (1/2)	9.525 (3/8)	3/8-24	9.525 (3/8)
11.112 (7/16)	CR 16 VBR	CR 16 VB	CR 16 VBUUR	CR 16 VBUU	74	25.400 (1)	15.875 (5/8)	11.112 (7/16)	7/16-20	12.700 (1/2)
	CR 18 VBR	CR 18 VB	CR 18 VBUUR	CR 18 VBUU	101	28.575 (1 1/8)	15.875 (5/8)	11.112 (7/16)	7/16-20	12.700 (1/2)
12.700 (1/2)	CR 20 VBR	CR 20 VB	CR 20 VBUUR	CR 20 VBUU	137	31.750 (1 1/4)	19.050 (3/4)	12.700 (1/2)	1/2-20	15.875 (5/8)
	CR 22 VBR	CR 22 VB	CR 22 VBUUR	CR 22 VBUU	160	34.925 (1 3/8)	19.050 (3/4)	12.700 (1/2)	1/2-20	15.875 (5/8)
15.875 (5/8)	CR 24 VBR	CR 24 VB	CR 24 VBUUR	CR 24 VBUU	230	38.100 (1 1/2)	22.225 (7/8)	15.875 (5/8)	5/8-18	19.050 (3/4)
	CR 26 VBR	CR 26 VB	CR 26 VBUUR	CR 26 VBUU	265	41.275 (1 5/8)	22.225 (7/8)	15.875 (5/8)	5/8-18	19.050 (3/4)
19.050 (3/4)	CR 28 VBR	CR 28 VB	CR 28 VBUUR	CR 28 VBUU	372	44.450 (1 3/4)	25.400 (1)	19.050 (3/4)	3/4-16	22.225 (7/8)
	CR 30 VBR	CR 30 VB	CR 30 VBUUR	CR 30 VBUU	418	47.625 (1 7/8)	25.400 (1)	19.050 (3/4)	3/4-16	22.225 (7/8)
22.225 (7/8)	CR 32 VBR	CR 32 VB	CR 32 VBUUR	CR 32 VBUU	627	50.800 (2)	31.750 (1 1/4)	22.225 (7/8)	7/8-14	25.400 (1)
	CR 36 VBR	CR 36 VB	CR 36 VBUUR	CR 36 VBUU	759	57.150 (2 1/4)	31.750 (1 1/4)	22.225 (7/8)	7/8-14	25.400 (1)

Remarks 1. Models with a stud diameter d₁ of 6.35 mm or less have no oil hole. Other models are provided with one oil hole each on the outside surface and end surface of the stud.
 2. Provided with prepacked grease.
 3. For the maximum allowable static load, please contact IKO.

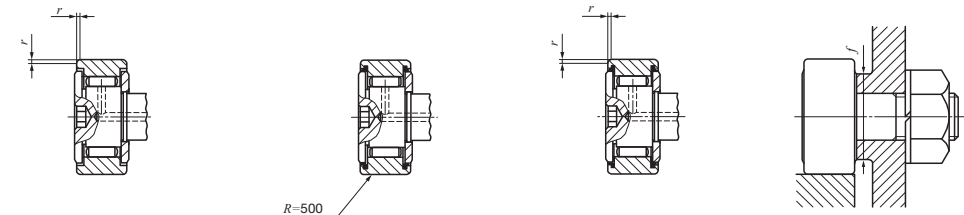

CR...VB

CR...VBUUR

CR...VBUU

Boundary dimensions mm (inch)								Mounting dimension f Min. mm (inch)	Maximum tightening torque N-m	Basic dynamic load rating C N	Basic static load rating C ₀ N
B max	B ₂	B ₃	C ₁	g ₁	g ₂	H	r				
10.2 (0.40)	12.700 (1/2)	— (—)	0.794 (1/32)	— (—)	— (—)	3.175 (1/8)	0.397 (1/64)	8.334 (21/64)	1.4	4 260	4 750
10.9 (0.43)	15.875 (5/8)	— (—)	0.794 (1/32)	— (—)	— (—)	3.175 (1/8)	0.397 (1/64)	8.334 (21/64)	1.4	4 710	5 410
11.8 (0.46)	15.875 (5/8)	— (—)	0.794 (1/32)	— (—)	— (—)	3.175 (1/8)	0.397 (1/64)	11.509 (29/64)	3.4	5 830	7 660
12.5 (0.49)	19.050 (3/4)	— (—)	0.794 (1/32)	— (—)	— (—)	3.175 (1/8)	0.397 (1/64)	11.509 (29/64)	3.4	6 340	8 530
14.2 (0.56)	22.225 (7/8)	6.350 (1/4)	0.794 (1/32)	4.762 (3/16)	2.381 (3/32)	4.762 (3/16)	0.794 (1/32)	13.494 (17/32)	10.8	8 710	12 300
14.2 (0.56)	22.225 (7/8)	6.350 (1/4)	0.794 (1/32)	4.762 (3/16)	2.381 (3/32)	4.762 (3/16)	0.794 (1/32)	15.081 (19/32)	10.8	8 710	12 300
17.3 (0.68)	25.400 (1)	6.350 (1/4)	0.794 (1/32)	4.762 (3/16)	3.175 (1/8)	6.350 (1/4)	1.191 (3/64)	17.859 (45/64)	17.4	13 100	22 700
17.3 (0.68)	25.400 (1)	6.350 (1/4)	0.794 (1/32)	4.762 (3/16)	3.175 (1/8)	6.350 (1/4)	1.588 (1/16)	19.050 (3/4)	17.4	13 100	22 700
20.4 (0.80)	31.750 (1 1/4)	7.938 (5/16)	0.794 (1/32)	4.762 (3/16)	3.175 (1/8)	6.350 (1/4)	1.588 (1/16)	21.828 (55/64)	27.7	23 600	31 700
20.4 (0.80)	31.750 (1 1/4)	7.938 (5/16)	0.794 (1/32)	4.762 (3/16)	3.175 (1/8)	6.350 (1/4)	1.588 (1/16)	21.828 (55/64)	27.7	23 600	31 700
23.6 (0.93)	38.100 (1 1/2)	9.525 (3/8)	0.794 (1/32)	4.762 (3/16)	3.969 (5/32)	7.938 (5/16)	1.588 (1/16)	26.196 (1 3/64)	55.7	28 200	40 100
23.6 (0.93)	38.100 (1 1/2)	9.525 (3/8)	0.794 (1/32)	4.762 (3/16)	3.969 (5/32)	7.938 (5/16)	1.588 (1/16)	26.196 (1 3/64)	55.7	28 200	40 100
26.8 (1.06)	44.450 (1 3/4)	11.112 (7/16)	0.794 (1/32)	4.762 (3/16)	3.969 (5/32)	7.938 (5/16)	1.588 (1/16)	32.543 (1 9/32)	100	35 300	55 600
26.8 (1.06)	44.450 (1 3/4)	11.112 (7/16)	0.794 (1/32)	4.762 (3/16)	3.969 (5/32)	7.938 (5/16)	1.588 (1/16)	32.543 (1 9/32)	100	35 300	55 600
33.5 (1.32)	50.800 (2)	12.700 (1/2)	0.794 (1/32)	4.762 (3/16)	4.762 (3/16)	11.112 (7/16)	1.588 (1/16)	37.306 (1 15/32)	162	45 700	80 600
33.5 (1.32)	50.800 (2)	12.700 (1/2)	0.794 (1/32)	4.762 (3/16)	4.762 (3/16)	11.112 (7/16)	1.588 (1/16)	37.306 (1 15/32)	162	45 700	80 600

CF
CFKR
CFS
NUCF
CR

CAM FOLLOWERS

Inch Series Cam Followers Full Complement Type/Stud Head Hex Hole

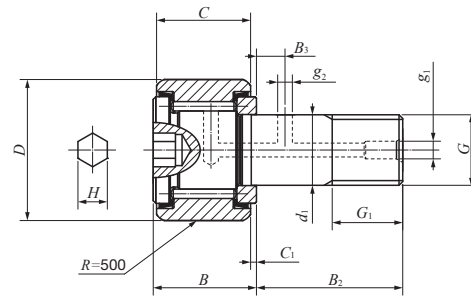

CR...VBSR

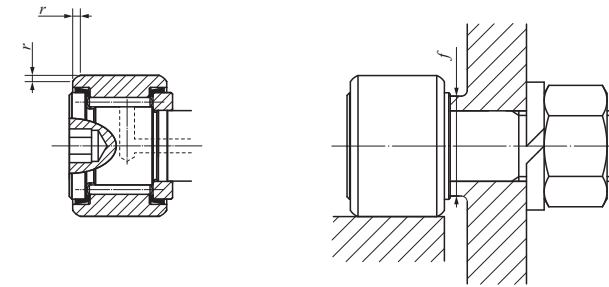

CR...VBS

Stud dia. 4.826 – 22.225mm

Stud dia. mm (inch)	Identification number		Mass (Ref.) g	Boundary dimensions mm (inch)						
	Sealed type with ThrustDisk Seals™			D	C	d ₁	G UNF	G ₁	B max	B ₂
	With crowned outer ring	With cylindrical outer ring								
4.826	CR 8 VBSR	CR 8 VBS	9	12.700 (1/2)	8.731 (11/32)	4.826	No.10-32	6.350 (1/4)	10.2(0.40)	12.700 (1/2)
	CR 8-1 VBSR	CR 8-1 VBS	10	12.700 (1/2)	9.525 (3/8)	4.826	No.10-32	6.350 (1/4)	10.9(0.43)	15.875 (5/8)
6.350 (1/4)	CR 10 VBSR	CR 10 VBS	19	15.875 (5/8)	10.319 (13/32)	6.350 (1/4)	1/4-28	7.938 (5/16)	11.8(0.46)	15.875 (5/8)
	CR 10-1 VBSR	CR 10-1 VBS	21	15.875 (5/8)	11.112 (7/16)	6.350 (1/4)	1/4-28	7.938 (5/16)	12.5(0.49)	19.050 (3/4)
9.525 (3/8)	CR 12 VBSR	CR 12 VBS	34	19.050 (3/4)	12.700 (1/2)	9.525 (3/8)	5/8-24	9.525 (3/8)	14.2(0.56)	22.225 (7/8)
	CR 14 VBSR	CR 14 VBS	45	22.225 (7/8)	12.700 (1/2)	9.525 (3/8)	5/8-24	9.525 (3/8)	14.2(0.56)	22.225 (7/8)
11.112 (7/16)	CR 16 VBSR	CR 16 VBS	73	25.400 (1)	15.875 (5/8)	11.112 (7/16)	7/16-20	12.700 (1/2)	17.3(0.68)	25.400 (1)
	CR 18 VBSR	CR 18 VBS	100	28.575 (1 1/8)	15.875 (5/8)	11.112 (7/16)	7/16-20	12.700 (1/2)	17.3(0.68)	25.400 (1)
12.700 (1/2)	CR 20 VBSR	CR 20 VBS	136	31.750 (1 1/4)	19.050 (3/4)	12.700 (1/2)	1/2-20	15.875 (5/8)	20.4(0.80)	31.750 (1 1/4)
	CR 22 VBSR	CR 22 VBS	159	34.925 (1 3/8)	19.050 (3/4)	12.700 (1/2)	1/2-20	15.875 (5/8)	20.4(0.80)	31.750 (1 1/4)
15.875 (5/8)	CR 24 VBSR	CR 24 VBS	230	38.100 (1 1/2)	22.225 (7/8)	15.875 (5/8)	3/8-18	19.050 (3/4)	23.6(0.93)	38.100 (1 1/2)
	CR 26 VBSR	CR 26 VBS	265	41.275 (1 5/8)	22.225 (7/8)	15.875 (5/8)	3/8-18	19.050 (3/4)	23.6(0.93)	38.100 (1 1/2)
19.050 (3/4)	CR 28 VBSR	CR 28 VBS	368	44.450 (1 3/4)	25.400 (1)	19.050 (3/4)	1/2-16	22.225 (7/8)	26.8(1.06)	44.450 (1 3/4)
	CR 30 VBSR	CR 30 VBS	413	47.625 (1 7/8)	25.400 (1)	19.050 (3/4)	1/2-16	22.225 (7/8)	26.8(1.06)	44.450 (1 3/4)
22.225 (7/8)	CR 32 VBSR	CR 32 VBS	620	50.800 (2)	31.750 (1 1/4)	22.225 (7/8)	5/8-14	25.400 (1)	33.5(1.32)	50.800 (2)
	CR 36 VBSR	CR 36 VBS	753	57.150 (2 1/4)	31.750 (1 1/4)	22.225 (7/8)	5/8-14	25.400 (1)	33.5(1.32)	50.800 (2)

Remarks 1. Models with a stud diameter d_1 of 6.35 mm or less have no oil hole. Other models are provided with one oil hole each on the outside surface and end surface of the stud.
 2. Provided with prepacked grease.
 3. For the maximum allowable static load, please contact IKO.

Boundary dimensions mm (inch)						Mounting dimension f Min. mm (inch)	Maximum tightening torque N-m	Basic dynamic load rating C N	Basic static load rating C ₀ N
B ₃	C ₁	g ₁	g ₂	H	r				
— (—)	0.794 (1/32)	— (—)	— (—)	3.175 (1/8)	0.397 (1/64)	8.334 (21/64)	1.4	3 790	4 100
— (—)	0.794 (1/32)	— (—)	— (—)	3.175 (1/8)	0.397 (1/64)	8.334 (21/64)	1.4	4 260	4 750
— (—)	0.794 (1/32)	— (—)	— (—)	3.175 (1/8)	0.397 (1/64)	11.509 (29/64)	3.4	5 310	6 780
— (—)	0.794 (1/32)	— (—)	— (—)	3.175 (1/8)	0.397 (1/64)	11.509 (29/64)	3.4	5 830	7 660
6.350 (1/4)	0.794 (1/32)	4.762 (3/16)	2.381 (3/32)	4.762 (3/16)	0.794 (1/32)	13.494 (17/32)	10.8	7 400	11 100
6.350 (1/4)	0.794 (1/32)	4.762 (3/16)	2.381 (3/32)	4.762 (3/16)	0.794 (1/32)	15.081 (19/32)	10.8	7 400	11 100
6.350 (1/4)	0.794 (1/32)	4.762 (3/16)	3.175 (1/8)	6.350 (1/4)	1.191 (3/64)	17.859 (45/64)	17.4	12,000	20,300
6.350 (1/4)	0.794 (1/32)	4.762 (3/16)	3.175 (1/8)	6.350 (1/4)	1.588 (1/16)	19.050 (3/4)	17.4	12,000	20,300
7.938 (5/16)	0.794 (1/32)	4.762 (3/16)	3.175 (1/8)	6.350 (1/4)	1.588 (1/16)	21.828 (55/64)	27.7	22,000	29,000
7.938 (5/16)	0.794 (1/32)	4.762 (3/16)	3.175 (1/8)	6.350 (1/4)	1.588 (1/16)	21.828 (55/64)	27.7	22,000	29,000
9.525 (3/8)	0.794 (1/32)	4.762 (3/16)	3.969 (5/32)	7.938 (5/16)	1.588 (1/16)	26.196 (1 1/64)	55.7	26,400	36,900
9.525 (3/8)	0.794 (1/32)	4.762 (3/16)	3.969 (5/32)	7.938 (5/16)	1.588 (1/16)	26.196 (1 1/64)	55.7	26,400	36,900
11.112 (7/16)	0.794 (1/32)	4.762 (3/16)	3.969 (5/32)	7.938 (5/16)	1.588 (1/16)	32.543 (1 3/32)	100	32,200	49,500
11.112 (7/16)	0.794 (1/32)	4.762 (3/16)	3.969 (5/32)	7.938 (5/16)	1.588 (1/16)	32.543 (1 3/32)	100	32,200	49,500
12.700 (1/2)	0.794 (1/32)	4.762 (3/16)	4.762 (3/16)	11.112 (7/16)	1.588 (1/16)	37.306 (1 15/32)	162	42,600	73,700
12.700 (1/2)	0.794 (1/32)	4.762 (3/16)	4.762 (3/16)	11.112 (7/16)	1.588 (1/16)	37.306 (1 15/32)	162	42,600	73,700

CF
CFKR
CFS
NUCF
CR

CAM FOLLOWERS

Inch Series Cam Followers Full Complement Type/With Screwdriver Slot

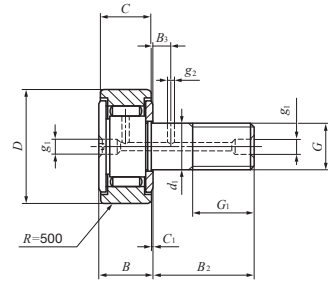
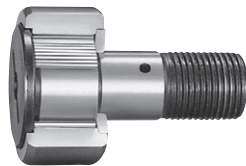

CR...VR

Stud dia. 4.826 – 31.750mm

Stud dia. mm (inch)	Identification number				Mass (Ref.) g	D	C	d ₁	G UNF	G ₁
	Shield type		Sealed type							
	With crowned outer ring	With cylindrical outer ring	With crowned outer ring	With cylindrical outer ring						
4.826	CR 8 VR	CR 8 V	CR 8 VUUR	CR 8 VUU	9	12.700 (1/2)	8.731 (11/32)	4.826	No.10-32	6.350 (1/4)
	CR 8-1 VR	CR 8-1 V	CR 8-1 VUUR	CR 8-1 VUU	10	12.700 (1/2)	9.525 (3/8)	4.826	No.10-32	6.350 (1/4)
6.350 (1/4)	CR 10 VR	CR 10 V	CR 10 VUUR	CR 10 VUU	19	15.875 (5/8)	10.319 (13/32)	6.350 (1/4)	1/4-28	7.938 (5/16)
	CR 10-1 VR	CR 10-1 V	CR 10-1 VUUR	CR 10-1 VUU	21	15.875 (5/8)	11.112 (7/16)	6.350 (1/4)	1/4-28	7.938 (5/16)
9.525 (3/8)	CR 12 VR	CR 12 V	CR 12 VUUR	CR 12 VUU	36	19.050 (3/4)	12.700 (1/2)	9.525 (3/8)	3/8-24	9.525 (3/8)
	CR 14 VR	CR 14 V	CR 14 VUUR	CR 14 VUU	47	22.225 (7/8)	12.700 (1/2)	9.525 (3/8)	3/8-24	9.525 (3/8)
11.112 (7/16)	CR 16 VR	CR 16 V	CR 16 VUUR	CR 16 VUU	74	25.400 (1)	15.875 (5/8)	11.112 (7/16)	7/16-20	12.700 (1/2)
	CR 18 VR	CR 18 V	CR 18 VUUR	CR 18 VUU	101	28.575 (1 1/8)	15.875 (5/8)	11.112 (7/16)	7/16-20	12.700 (1/2)
12.700 (1/2)	CR 20 VR	CR 20 V	CR 20 VUUR	CR 20 VUU	137	31.750 (1 1/4)	19.050 (3/4)	12.700 (1/2)	1/2-20	15.875 (5/8)
	CR 22 VR	CR 22 V	CR 22 VUUR	CR 22 VUU	160	34.925 (1 3/8)	19.050 (3/4)	12.700 (1/2)	1/2-20	15.875 (5/8)
15.875 (5/8)	CR 24 VR	CR 24 V	CR 24 VUUR	CR 24 VUU	230	38.100 (1 1/2)	22.225 (7/8)	15.875 (5/8)	5/8-18	19.050 (3/4)
	CR 26 VR	CR 26 V	CR 26 VUUR	CR 26 VUU	265	41.275 (1 5/8)	22.225 (7/8)	15.875 (5/8)	5/8-18	19.050 (3/4)
19.050 (3/4)	CR 28 VR	CR 28 V	CR 28 VUUR	CR 28 VUU	372	44.450 (1 3/4)	25.400 (1)	19.050 (3/4)	3/4-16	22.225 (7/8)
	CR 30 VR	CR 30 V	CR 30 VUUR	CR 30 VUU	418	47.625 (1 7/8)	25.400 (1)	19.050 (3/4)	3/4-16	22.225 (7/8)
22.225 (7/8)	CR 32 VR	CR 32 V	CR 32 VUUR	CR 32 VUU	627	50.800 (2)	31.750 (1 1/4)	22.225 (7/8)	7/8-14	25.400 (1)
	CR 36 VR	CR 36 V	CR 36 VUUR	CR 36 VUU	759	57.150 (2 1/4)	31.750 (1 1/4)	22.225 (7/8)	7/8-14	25.400 (1)
31.750 (1 1/4)	—	—	—	CR 48 VUU	1960	76.200 (3)	44.450 (1 3/4)	31.750 (1 1/4)	1 1/4-12	31.750 (1 1/4)

Remarks1. Models with a stud diameter d₁ of 6.35 mm or less (marked *) are provided with an oil hole on the stud head only. Other models are provided with one oil hole each on the head, outside surface and end surface of the stud.
 2. Provided with prepacked grease.
 3. For the maximum allowable static load, please contact IKO.

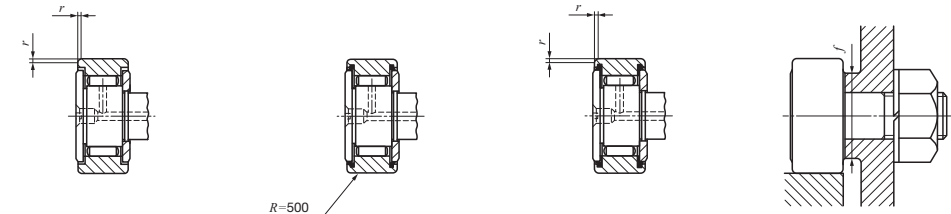

CR...V

CR...VUUR

CR...VUU

Boundary dimensions mm(inch)							Mounting dimension f Min. mm(inch)	Maximum tightening torque N-m	Basic dynamic load rating C N	Basic static load rating C ₀ N
B max	B ₂	B ₃	C ₁	g ₁	g ₂	r				
10.2 (0.40)	12.700 (1/2)	— (—)	0.794 (1/32)	*3.175 (1/8)	— (—)	0.397 (1/64)	8.334 (21/64)	1.4	4 260	4 750
10.9 (0.43)	15.875 (5/8)	— (—)	0.794 (1/32)	*3.175 (1/8)	— (—)	0.397 (1/64)	8.334 (21/64)	1.4	4 710	5 410
11.8 (0.46)	15.875 (5/8)	— (—)	0.794 (1/32)	*3.175 (1/8)	— (—)	0.397 (1/64)	11.509 (29/64)	3.4	5 830	7 660
12.5 (0.49)	19.050 (3/4)	— (—)	0.794 (1/32)	*3.175 (1/8)	— (—)	0.397 (1/64)	11.509 (29/64)	3.4	6 340	8 530
14.2 (0.56)	22.225 (7/8)	6.350 (1/4)	0.794 (1/32)	4.762 (3/16)	2.381 (3/32)	0.794 (1/32)	13.494 (17/32)	10.8	8 710	12 300
14.2 (0.56)	22.225 (7/8)	6.350 (1/4)	0.794 (1/32)	4.762 (3/16)	2.381 (3/32)	0.794 (1/32)	15.081 (19/32)	10.8	8 710	12 300
17.3 (0.68)	25.400 (1)	6.350 (1/4)	0.794 (1/32)	4.762 (3/16)	3.175 (1/8)	1.191 (3/64)	17.859 (45/64)	17.4	13 100	22 700
17.3 (0.68)	25.400 (1)	6.350 (1/4)	0.794 (1/32)	4.762 (3/16)	3.175 (1/8)	1.588 (1/16)	19.050 (3/4)	17.4	13 100	22 700
20.4 (0.80)	31.750 (1 1/4)	7.938 (5/16)	0.794 (1/32)	4.762 (3/16)	3.175 (1/8)	1.588 (1/16)	21.828 (55/64)	27.7	23 600	31 700
20.4 (0.80)	31.750 (1 1/4)	7.938 (5/16)	0.794 (1/32)	4.762 (3/16)	3.175 (1/8)	1.588 (1/16)	21.828 (55/64)	27.7	23 600	31 700
23.6 (0.93)	38.100 (1 1/2)	9.525 (3/8)	0.794 (1/32)	4.762 (3/16)	3.969 (5/32)	1.588 (1/16)	26.196 (1 3/64)	55.7	28 200	40 100
23.6 (0.93)	38.100 (1 1/2)	9.525 (3/8)	0.794 (1/32)	4.762 (3/16)	3.969 (5/32)	1.588 (1/16)	26.196 (1 3/64)	55.7	28 200	40 100
26.8 (1.06)	44.450 (1 3/4)	11.112 (7/16)	0.794 (1/32)	4.762 (3/16)	3.969 (5/32)	1.588 (1/16)	32.543 (1 9/32)	100	35 300	55 600
26.8 (1.06)	44.450 (1 3/4)	11.112 (7/16)	0.794 (1/32)	4.762 (3/16)	3.969 (5/32)	1.588 (1/16)	32.543 (1 9/32)	100	35 300	55 600
33.5 (1.32)	50.800 (2)	12.700 (1/2)	0.794 (1/32)	4.762 (3/16)	4.762 (3/16)	1.588 (1/16)	37.306 (1 15/32)	162	45 700	80 600
33.5 (1.32)	50.800 (2)	12.700 (1/2)	0.794 (1/32)	4.762 (3/16)	4.762 (3/16)	1.588 (1/16)	37.306 (1 15/32)	162	45 700	80 600
46.4 (1.83)	63.500 (2 1/2)	15.875 (5/8)	1.588 (1/16)	6.350 (1/4)	4.762 (3/16)	2.381 (3/32)	51.991 (2 3/64)	500	77 600	172 000

I
CF
CFKR
CFS
NUCF
CR

CAM FOLLOWERS

Inch Series Heavy Duty Cam Followers Full Complement Type/Stud Head Hex Hole

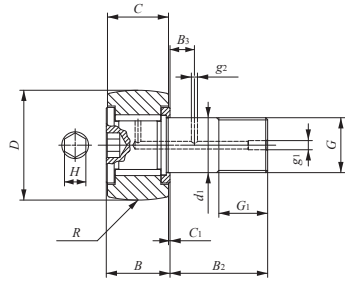
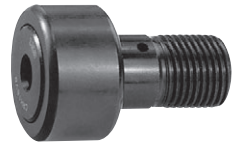

CRH...VBR

Stud dia. 6.350 — 50.800mm

Stud dia. mm (inch)	Identification number		Mass (Ref.) g	Boundary dimensions mm (inch)					
	Shield type With crowned outer ring	Sealed type With crowned outer ring		D	C	d ₁	G UNF	G ₁	B max
6.350 (1/4)	CRH 8-1 VBR	CRH 8-1 VBUUR	12	12.700 (1/2)	9.525 (3/8)	6.350 (1/4)	1/4 - 28	6.350 (1/4)	11.1 (0.44)
	CRH 9 VBR	CRH 9 VBUUR	15	14.288 (9/16)	9.525 (3/8)	6.350 (1/4)	1/4 - 28	6.350 (1/4)	11.1 (0.44)
7.938 (5/16)	CRH 10-1 VBR	CRH 10-1 VBUUR	23	15.875 (5/8)	11.112 (7/16)	7.938 (5/16)	5/16 - 24	7.938 (5/16)	12.8 (0.50)
	CRH 11 VBR	CRH 11 VBUUR	27	17.462 (11/16)	11.112 (7/16)	7.938 (5/16)	5/16 - 24	7.938 (5/16)	12.8 (0.50)
11.112 (7/16)	CRH 12 VBR	CRH 12 VBUUR	39	19.050 (3/4)	12.700 (1/2)	11.112 (7/16)	7/16 - 20	9.525 (3/8)	14.6 (0.57)
	CRH 14 VBR	CRH 14 VBUUR	49	22.225 (7/8)	12.700 (1/2)	11.112 (7/16)	7/16 - 20	9.525 (3/8)	14.6 (0.57)
15.875 (5/8)	CRH 16 VBR	CRH 16 VBUUR	93	25.400 (1)	15.875 (5/8)	15.875 (5/8)	5/8 - 18	12.700 (1/2)	17.9 (0.70)
	CRH 18 VBR	CRH 18 VBUUR	109	28.575 (1 1/8)	15.875 (5/8)	15.875 (5/8)	5/8 - 18	12.700 (1/2)	17.9 (0.70)
19.050 (3/4)	CRH 20 VBR	CRH 20 VBUUR	176	31.750 (1 1/4)	19.050 (3/4)	19.050 (3/4)	3/4 - 16	15.875 (5/8)	21.0 (0.83)
	CRH 22 VBR	CRH 22 VBUUR	200	34.925 (1 3/8)	19.050 (3/4)	19.050 (3/4)	3/4 - 16	15.875 (5/8)	21.0 (0.83)
22.225 (7/8)	CRH 24 VBR	CRH 24 VBUUR	296	38.100 (1 1/2)	22.225 (7/8)	22.225 (7/8)	7/8 - 14	19.050 (3/4)	24.3 (0.96)
	CRH 26 VBR	CRH 26 VBUUR	329	41.275 (1 5/8)	22.225 (7/8)	22.225 (7/8)	7/8 - 14	19.050 (3/4)	24.3 (0.96)
25.400 (1)	CRH 28 VBR	CRH 28 VBUUR	463	44.450 (1 3/4)	25.400 (1)	25.400 (1)	1 - 14 UNS	22.225 (7/8)	27.4 (1.08)
	CRH 30 VBR	CRH 30 VBUUR	508	47.625 (1 7/8)	25.400 (1)	25.400 (1)	1 - 14 UNS	22.225 (7/8)	27.4 (1.08)
28.575 (1 1/8)	CRH 32 VBR	CRH 32 VBUUR	722	50.800 (2)	31.750 (1 1/4)	28.575 (1 1/8)	1 1/8 - 12	25.400 (1)	34.2 (1.35)
	CRH 36 VBR	CRH 36 VBUUR	858	57.150 (2 1/4)	31.750 (1 1/4)	28.575 (1 1/8)	1 1/8 - 12	25.400 (1)	34.2 (1.35)
31.750 (1 1/4)	CRH 40 VBR	CRH 40 VBUUR	1 260	63.500 (2 1/2)	38.100 (1 1/2)	31.750 (1 1/4)	1 1/4 - 12	28.575 (1 1/8)	40.0 (1.57)
	CRH 44 VBR	CRH 44 VBUUR	1 460	69.850 (2 3/4)	38.100 (1 1/2)	31.750 (1 1/4)	1 1/4 - 12	28.575 (1 1/8)	40.0 (1.57)
38.100 (1 1/2)	CRH 48 VBR	CRH 48 VBUUR	2 100	76.200 (3)	44.450 (1 3/4)	38.100 (1 1/2)	1 1/2 - 12	31.750 (1 1/4)	46.4 (1.83)
	CRH 52 VBR	CRH 52 VBUUR	2 380	82.550 (3 1/4)	44.450 (1 3/4)	38.100 (1 1/2)	1 1/2 - 12	31.750 (1 1/4)	46.4 (1.83)
44.450 (1 3/4)	CRH 56 VBR	CRH 56 VBUUR	3 240	88.900 (3 1/2)	50.800 (2)	44.450 (1 3/4)	1 3/4 - 12UN	34.925 (1 3/8)	52.8 (2.08)
50.800 (2)	CRH 64 VBR	CRH 64 VBUUR	4 960	101.600 (4)	57.150 (2 1/4)	50.800 (2)	2 - 12 UN	38.100 (1 1/2)	59.4 (2.34)

Remarks 1. Models with a stud diameter d_1 of 7.938 mm or less have no oil hole. Other models are provided with one oil hole each on the outside surface and end surface of the stud.
 2. Provided with prepacked grease.
 3. For the maximum allowable static load, please contact IKO.



CRH...VBUUR

Boundary dimensions mm (inch)							Mounting dimension f Min. mm (inch)	Maximum tightening torque N-m	Basic dynamic load rating C N	Basic static load rating C ₀ N
B ₂	B ₃	C ₁	g ₁	g ₂	H	R				
15.875 (5/8)	— (—)	0.794 (1/32)	— (—)	— (—)	3.175 (1/8)	180 (7)	8.334 (21/64)	3.4	4 710	5 410
15.875 (5/8)	— (—)	0.794 (1/32)	— (—)	— (—)	3.175 (1/8)	180 (7)	8.334 (21/64)	3.4	4 710	5 410
19.050 (3/4)	— (—)	0.794 (1/32)	— (—)	— (—)	3.175 (1/8)	200 (8)	11.112 (7/16)	6.8	6 340	8 530
19.050 (3/4)	— (—)	0.794 (1/32)	— (—)	— (—)	3.175 (1/8)	200 (8)	11.112 (7/16)	6.8	6 340	8 530
22.225 (7/8)	6.350 (1/4)	0.794 (1/32)	4.762 (3/16)	2.381 (3/32)	4.762 (3/16)	250 (10)	13.494 (17/32)	17.6	8 710	12 300
22.225 (7/8)	6.350 (1/4)	0.794 (1/32)	4.762 (3/16)	2.381 (3/32)	4.762 (3/16)	250 (10)	13.494 (17/32)	17.6	8 710	12 300
25.400 (1)	6.350 (1/4)	1.588 (1/16)	4.762 (3/16)	2.381 (3/32)	6.350 (1/4)	300 (12)	18.256 (23/32)	57.8	13 100	22 700
25.400 (1)	6.350 (1/4)	1.588 (1/16)	4.762 (3/16)	2.381 (3/32)	6.350 (1/4)	300 (12)	18.256 (23/32)	57.8	13 100	22 700
31.750 (1 1/4)	7.938 (5/16)	1.588 (1/16)	4.762 (3/16)	2.381 (3/32)	6.350 (1/4)	360 (14)	24.209 (61/64)	103	23 600	31 700
31.750 (1 1/4)	7.938 (5/16)	1.588 (1/16)	4.762 (3/16)	2.381 (3/32)	6.350 (1/4)	360 (14)	24.209 (61/64)	103	23 600	31 700
38.100 (1 1/2)	9.525 (3/8)	1.588 (1/16)	4.762 (3/16)	2.381 (3/32)	7.938 (5/16)	500 (20)	26.988 (1 1/16)	162	28 200	40 100
38.100 (1 1/2)	9.525 (3/8)	1.588 (1/16)	4.762 (3/16)	2.381 (3/32)	7.938 (5/16)	500 (20)	26.988 (1 1/16)	162	28 200	40 100
44.450 (1 3/4)	11.112 (7/16)	1.588 (1/16)	4.762 (3/16)	2.381 (3/32)	7.938 (5/16)	500 (20)	32.941 (1 19/64)	258	35 300	55 600
44.450 (1 3/4)	11.112 (7/16)	1.588 (1/16)	4.762 (3/16)	2.381 (3/32)	7.938 (5/16)	500 (20)	32.941 (1 19/64)	258	35 300	55 600
50.800 (2)	12.700 (1/2)	1.588 (1/16)	4.762 (3/16)	3.175 (1/8)	11.112 (7/16)	600 (24)	37.306 (1 15/32)	356	45 700	80 600
50.800 (2)	12.700 (1/2)	1.588 (1/16)	4.762 (3/16)	3.175 (1/8)	11.112 (7/16)	600 (24)	37.306 (1 15/32)	356	45 700	80 600
57.150 (2 1/4)	14.288 (9/16)	1.588 (1/16)	4.762 (3/16)	3.175 (1/8)	12.700 (1/2)	760 (30)	40.878 (1 39/64)	500	61 400	116 000
57.150 (2 1/4)	14.288 (9/16)	1.588 (1/16)	4.762 (3/16)	3.175 (1/8)	12.700 (1/2)	760 (30)	40.878 (1 39/64)	500	61 400	116 000
63.500 (2 1/2)	15.875 (5/8)	1.588 (1/16)	6.350 (1/4)	3.175 (1/8)	19.050 (3/4)	760 (30)	51.991 (2 3/64)	892	77 600	172 000
63.500 (2 1/2)	15.875 (5/8)	1.588 (1/16)	6.350 (1/4)	3.175 (1/8)	19.050 (3/4)	760 (30)	51.991 (2 3/64)	892	77 600	172 000
69.850 (2 3/4)	17.462 (11/16)	1.588 (1/16)	6.350 (1/4)	3.175 (1/8)	19.050 (3/4)	760 (30)	59.928 (2 23/64)	1450	111 000	239 000
88.900 (3 1/2)	19.050 (3/4)	1.588 (1/16)	6.350 (1/4)	3.175 (1/8)	19.050 (3/4)	760 (30)	64.691 (2 35/64)	2190	142 000	317 000

CF
CFKR
CFS
NUCF
CR

CAM FOLLOWERS

Inch Series Heavy Duty Cam Followers Full Complement Type/Stud Head Hex Hole

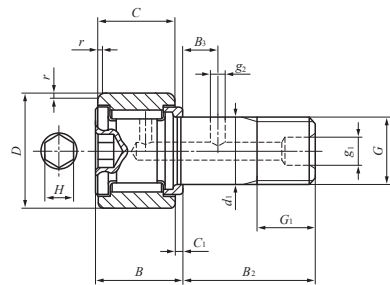
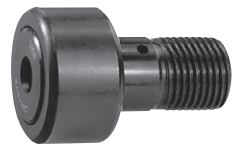

CRH...VB

Stud dia. 6.350 – 50.800mm

Stud dia. mm (inch)	Identification number		Mass (Ref.) g	Boundary dimensions mm (inch)					
	Shield type With cylindrical outer ring	Sealed type With cylindrical outer ring		D	C	d ₁	G UNF	G ₁	B max
6.350 (1/4)	CRH 8-1 VB	CRH 8-1 VBUU	12	12.700 (1/2)	9.525 (3/8)	6.350 (1/4)	1/4 - 28	6.350 (1/4)	11.1 (0.44)
	CRH 9 VB	CRH 9 VBUU	15	14.288 (9/16)	9.525 (3/8)	6.350 (1/4)	1/4 - 28	6.350 (1/4)	11.1 (0.44)
7.938 (5/16)	CRH 10-1 VB	CRH 10-1 VBUU	23	15.875 (5/8)	11.112 (7/16)	7.938 (5/16)	5/16 - 24	7.938 (5/16)	12.8 (0.50)
	CRH 11 VB	CRH 11 VBUU	27	17.462 (11/16)	11.112 (7/16)	7.938 (5/16)	5/16 - 24	7.938 (5/16)	12.8 (0.50)
11.112 (7/16)	CRH 12 VB	CRH 12 VBUU	39	19.050 (3/4)	12.700 (1/2)	11.112 (7/16)	7/16 - 20	9.525 (3/8)	14.6 (0.57)
	CRH 14 VB	CRH 14 VBUU	49	22.225 (7/8)	12.700 (1/2)	11.112 (7/16)	7/16 - 20	9.525 (3/8)	14.6 (0.57)
15.875 (5/8)	CRH 16 VB	CRH 16 VBUU	93	25.400 (1)	15.875 (5/8)	15.875 (5/8)	5/8 - 18	12.700 (1/2)	17.9 (0.70)
	CRH 18 VB	CRH 18 VBUU	109	28.575 (1 1/8)	15.875 (5/8)	15.875 (5/8)	5/8 - 18	12.700 (1/2)	17.9 (0.70)
19.050 (3/4)	CRH 20 VB	CRH 20 VBUU	176	31.750 (1 1/4)	19.050 (3/4)	19.050 (3/4)	3/4 - 16	15.875 (5/8)	21.0 (0.83)
	CRH 22 VB	CRH 22 VBUU	200	34.925 (1 3/8)	19.050 (3/4)	19.050 (3/4)	3/4 - 16	15.875 (5/8)	21.0 (0.83)
22.225 (7/8)	CRH 24 VB	CRH 24 VBUU	296	38.100 (1 1/2)	22.225 (7/8)	22.225 (7/8)	7/8 - 14	19.050 (3/4)	24.3 (0.96)
	CRH 26 VB	CRH 26 VBUU	329	41.275 (1 5/8)	22.225 (7/8)	22.225 (7/8)	7/8 - 14	19.050 (3/4)	24.3 (0.96)
25.400 (1)	CRH 28 VB	CRH 28 VBUU	463	44.450 (1 3/4)	25.400 (1)	25.400 (1)	1 - 14 UNS	22.225 (7/8)	27.4 (1.08)
	CRH 30 VB	CRH 30 VBUU	508	47.625 (1 7/8)	25.400 (1)	25.400 (1)	1 - 14 UNS	22.225 (7/8)	27.4 (1.08)
28.575 (1 1/8)	CRH 32 VB	CRH 32 VBUU	722	50.800 (2)	31.750 (1 1/4)	28.575 (1 1/8)	1 1/8 - 12	25.400 (1)	34.2 (1.35)
	CRH 36 VB	CRH 36 VBUU	858	57.150 (2 1/4)	31.750 (1 1/4)	28.575 (1 1/8)	1 1/8 - 12	25.400 (1)	34.2 (1.35)
31.750 (1 1/4)	CRH 40 VB	CRH 40 VBUU	1 260	63.500 (2 1/2)	38.100 (1 1/2)	31.750 (1 1/4)	1 1/4 - 12	28.575 (1 1/8)	40.0 (1.57)
	CRH 44 VB	CRH 44 VBUU	1 460	69.850 (2 3/4)	38.100 (1 1/2)	31.750 (1 1/4)	1 1/4 - 12	28.575 (1 1/8)	40.0 (1.57)
38.100 (1 1/2)	CRH 48 VB	CRH 48 VBUU	2 100	76.200 (3)	44.450 (1 3/4)	38.100 (1 1/2)	1 1/2 - 12	31.750 (1 1/4)	46.4 (1.83)
	CRH 52 VB	CRH 52 VBUU	2 380	82.550 (3 1/4)	44.450 (1 3/4)	38.100 (1 1/2)	1 1/2 - 12	31.750 (1 1/4)	46.4 (1.83)
44.450 (1 3/4)	CRH 56 VB	CRH 56 VBUU	3 240	88.900 (3 1/2)	50.800 (2)	44.450 (1 3/4)	1 3/4 - 12UN	34.925 (1 3/8)	52.8 (2.08)
50.800 (2)	CRH 64 VB	CRH 64 VBUU	4 960	101.600 (4)	57.150 (2 1/4)	50.800 (2)	2 - 12 UN	38.100 (1 1/2)	59.4 (2.34)

Remarks1. Models with a stud diameter d₁ of 7.938 mm or less have no oil hole. Other models are provided with one oil hole each on the outside surface and end surface of the stud.
2. Provided with prepacked grease.
3. For the maximum allowable static load, please contact IKO.

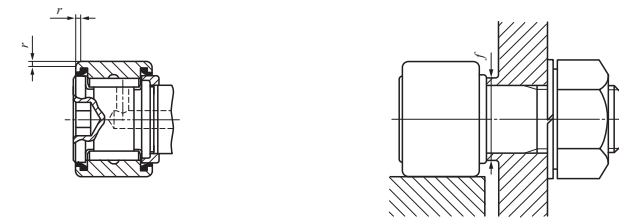

CRH...VBUU

Boundary dimensions mm (inch)							Mounting dimension f Min. mm (inch)	Maximum tightening torque N-m	Basic dynamic load rating C N	Basic static load rating C ₀ N
B ₂	B ₃	C ₁	g ₁	g ₂	H	r				
15.875 (5/8)	— (—)	0.794 (1/32)	— (—)	— (—)	3.175 (1/8)	0.397 (1/64)	8.334 (21/64)	3.4	4 710	5 410
15.875 (5/8)	— (—)	0.794 (1/32)	— (—)	— (—)	3.175 (1/8)	0.397 (1/64)	8.334 (21/64)	3.4	4 710	5 410
19.050 (3/4)	— (—)	0.794 (1/32)	— (—)	— (—)	3.175 (1/8)	0.397 (1/64)	11.112 (7/16)	6.8	6 340	8 530
19.050 (3/4)	— (—)	0.794 (1/32)	— (—)	— (—)	3.175 (1/8)	0.397 (1/64)	11.112 (7/16)	6.8	6 340	8 530
22.225 (7/8)	6.350 (1/4)	0.794 (1/32)	4.762 (3/16)	2.381 (3/32)	4.762 (3/16)	0.794 (1/32)	13.494 (17/32)	17.6	8 710	12 300
22.225 (7/8)	6.350 (1/4)	0.794 (1/32)	4.762 (3/16)	2.381 (3/32)	4.762 (3/16)	0.794 (1/32)	13.494 (17/32)	17.6	8 710	12 300
25.400 (1)	6.350 (1/4)	1.588 (1/16)	4.762 (3/16)	2.381 (3/32)	6.350 (1/4)	1.191 (3/64)	18.256 (23/32)	57.8	13 100	22 700
25.400 (1)	6.350 (1/4)	1.588 (1/16)	4.762 (3/16)	2.381 (3/32)	6.350 (1/4)	1.588 (1/16)	18.256 (23/32)	57.8	13 100	22 700
31.750 (1 1/4)	7.938 (5/16)	1.588 (1/16)	4.762 (3/16)	2.381 (3/32)	6.350 (1/4)	1.588 (1/16)	24.209 (61/64)	103	23 600	31 700
31.750 (1 1/4)	7.938 (5/16)	1.588 (1/16)	4.762 (3/16)	2.381 (3/32)	6.350 (1/4)	1.588 (1/16)	24.209 (61/64)	103	23 600	31 700
38.100 (1 1/2)	9.525 (3/8)	1.588 (1/16)	4.762 (3/16)	2.381 (3/32)	7.938 (5/16)	1.588 (1/16)	26.988 (1 1/16)	162	28 200	40 100
38.100 (1 1/2)	9.525 (3/8)	1.588 (1/16)	4.762 (3/16)	2.381 (3/32)	7.938 (5/16)	1.588 (1/16)	26.988 (1 1/16)	162	28 200	40 100
44.450 (1 3/4)	11.112 (7/16)	1.588 (1/16)	4.762 (3/16)	2.381 (3/32)	7.938 (5/16)	1.588 (1/16)	32.941 (1 19/64)	258	35 300	55 600
44.450 (1 3/4)	11.112 (7/16)	1.588 (1/16)	4.762 (3/16)	2.381 (3/32)	7.938 (5/16)	1.588 (1/16)	32.941 (1 19/64)	258	35 300	55 600
50.800 (2)	12.700 (1/2)	1.588 (1/16)	4.762 (3/16)	3.175 (1/8)	11.112 (7/16)	1.588 (1/16)	37.306 (1 15/32)	356	45 700	80 600
50.800 (2)	12.700 (1/2)	1.588 (1/16)	4.762 (3/16)	3.175 (1/8)	11.112 (7/16)	1.588 (1/16)	37.306 (1 15/32)	356	45 700	80 600
57.150 (2 1/4)	14.288 (9/16)	1.588 (1/16)	4.762 (3/16)	3.175 (1/8)	12.700 (1/2)	2.381 (3/32)	40.878 (1 39/64)	500	61 400	116 000
57.150 (2 1/4)	14.288 (9/16)	1.588 (1/16)	4.762 (3/16)	3.175 (1/8)	12.700 (1/2)	2.381 (3/32)	40.878 (1 39/64)	500	61 400	116 000
63.500 (2 1/2)	15.875 (5/8)	1.588 (1/16)	6.350 (1/4)	3.175 (1/8)	19.050 (3/4)	2.381 (3/32)	51.991 (2 3/64)	892	77 600	172 000
63.500 (2 1/2)	15.875 (5/8)	1.588 (1/16)	6.350 (1/4)	3.175 (1/8)	19.050 (3/4)	2.381 (3/32)	51.991 (2 3/64)	892	77 600	172 000
69.850 (2 3/4)	17.462 (11/16)	1.588 (1/16)	6.350 (1/4)	3.175 (1/8)	19.050 (3/4)	2.381 (3/32)	59.928 (2 23/64)	1 450	111 000	239 000
88.900 (3 1/2)	19.050 (3/4)	1.588 (1/16)	6.350 (1/4)	3.175 (1/8)	19.050 (3/4)	2.381 (3/32)	64.691 (2 35/64)	2 190	142 000	317 000

CF
CFKR
CFS
NUCF
CR